

FR/ Annexe ES/ Apéndice PT/ Anexo IT/ Appendice
EL/ Παράρτημα PL/ Załącznik RU/ Приложение UK/ Додаток
RO/ Anexa EN/ Appendix

Ean code	**Model No.	size(mm)	profile
3276000236870	RE-FO70-S-C	700x1950	bright chrome
3276000236900	RE-FO70-M-C	700x1950	mat black
3276000236917	RE-FO80-S-C	800x1950	bright chrome
3276000236962	RE-FO80-M-C	800x1950	mat black
3276000236948	RE-FO90-S-C	900x1950	bright chrome
3276000236986	RE-FO90-M-C	900x1950	mat black
3276000236993	RE-FO100-S-C	1000x1950	bright chrome
3276000237020	RE-FO100-M-C	1000x1950	mat black

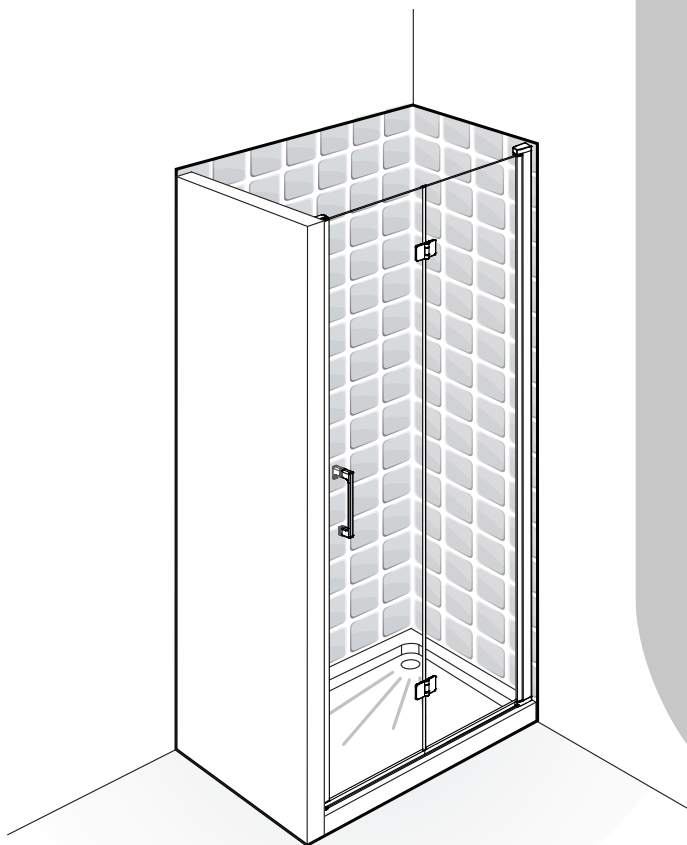

REMIX



- FR** Notice de Montage, Utilisation, Entretien
- ES** Instrucciones de Montaje, Utilización y Mantenimiento
- PT** Instruções de Montagem, Utilização e Manutenção
- IT** Istruzioni per il Montaggio, l'Uso e la Manutenzione
- EL** Εγχειρίδιο συναρμολόγησης, χρήσης και συντήρησης
- PL** Instrukcja Montażu, Użytkowania i Konserwacji
- RU** Руководство По Сборке и Эксплуатации
- UK** Керівництво По Збірці і Експлуатації
- RO** Manual asamblare, utilizare și întreținere
- EN** Assembly - Use - Maintenance Manual

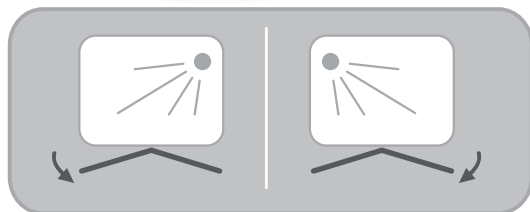

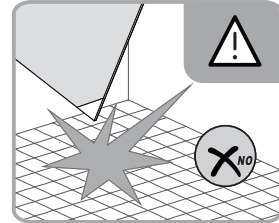
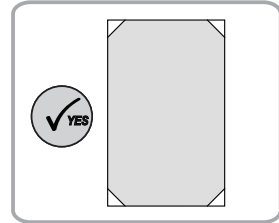
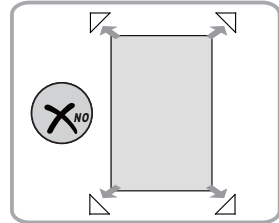
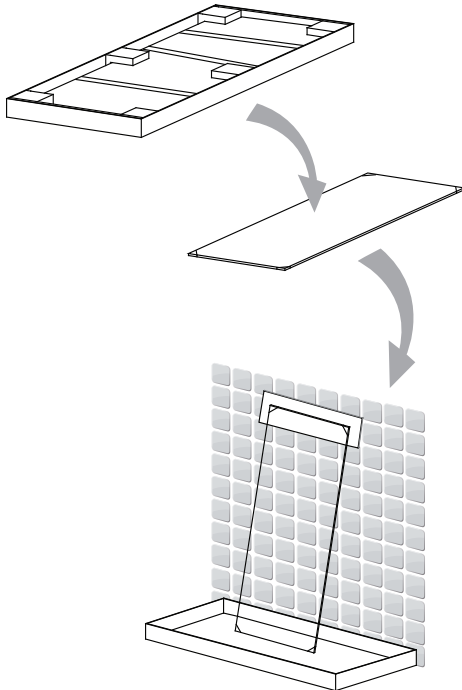
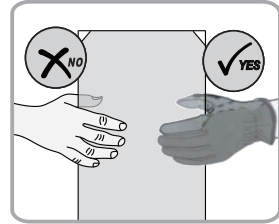
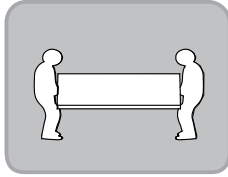
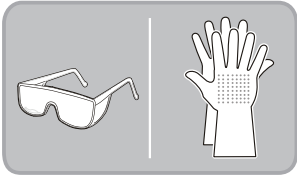
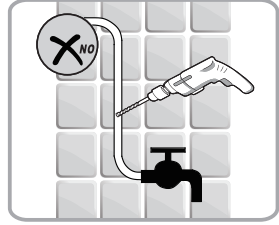
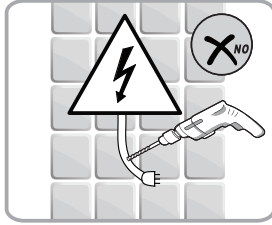
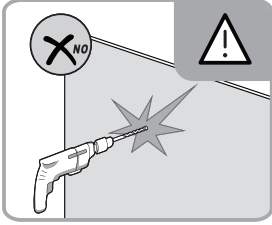

FR Vérifiez que les chevilles murales fournies sont appropriées à votre mur (celles fournies dans l'emballage sont conçues pour le béton). Sinon, utilisez des vis et des chevilles murales adaptées au type de matériau de votre mur. Pour obtenir des conseils concernant les vis et les chevilles appropriées à votre mur, demandez à un vendeur spécialisé.

ES Compruebe que todos los tacos suministrados puedan ser utilizados con su pared (los incluidos en la caja son para hormigón). En caso contrario, utilice tornillos y tacos de pared apropiados para el material de su pared. Para información acerca de las fijaciones y tornillos apropiados para su pared, consulte con un asistente de ventas especializado.

PT Certifique-se de que as buchas fornecidas são adequadas à sua parede (as fornecidas na embalagem são para betão). Caso contrário, use parafusos e buchas adequados ao tipo de material da sua parede. Para se aconselhar acerca dos parafusos e buchas adequados à sua parede, fale com um assistente de vendas especializado.

IT Verificare che i tasselli da parete forniti siano compatibili con la propria parete (quelli forniti con l'articolo sono per cemento). Altrimenti, utilizzare viti e tasselli adatti per la superficie della propria parete. Per ottenere consigli e suggerimenti sulle viti e i tasselli più adatti alla propria parete, consultare un rivenditore specializzato.

EL Βεβαιωθείτε ότι οι παρεχόμενες στερεώσεις τοίχου είναι κατάλληλες για τον τοίχο σας (οι παρεχόμενες στη συσκευή προορίζονται για μπετό). Αλλιώς χρησιμοποιήστε βίδες και στερεώσεις τοίχου κατάλληλες για τον τύπο υλικού του τοίχου σας. Για να λάβετε συμβουλές σχετικά με τις κατάλληλες βίδες και τα εξαρτήματα για τον τοίχο σας, ρωτήστε έναν ειδικό πωλητή.

PL Prosimy sprawdzić, czy dostarczone kołki do ścian nadają się do użycia w posiadanej ścianie (kołki dostarczone w zestawie są przeznaczone do betonu). Jeśli tak nie jest, należy użyć śrub i kołków odpowiednich do materiału, z którego wykonana jest ściana. Aby uzyskać poradę w sprawie śrub i elementów montażowych odpowiednich do danego typu ściany, należy zwrócić się z pytaniem do wyspecjalizowanego sprzedawcy.

RU Убедитесь, что прилагаемые дюбеля подходят для ваших стен (входящие в комплект дюбеля предназначены для бетона). В противном случае используйте шурупы и дюбеля, соответствующие материалу стены. Для получения рекомендаций по выбору шурупов и крепежных деталей, подходящих для вашей стены, обратитесь к специалисту-консультанту.

UK Перевірте, що анкери підходять для вашої стіни (ті, що постачаються в упаковці – для бетону). В іншому випадку використовуйте гвинти й стінові анкери, що відповідають матеріалу вашої стіни. Для отримання консультацій щодо гвинтів й фітінгів для вашої стіни зверніться до відповідного продавця-консультанта.

RO Verificați ca toate ancorele de perete furnizate să fie adecvate pentru peretele dumneavoastră (cele furnizate în pachet sunt pentru beton). În caz contrar, folosiți șuruburi și ancore de perete adecvate pentru tipul de material din care este peretele dumneavoastră. Pentru a obține recomandări privind șuruburile și armăturile adecvate pentru peretele dumneavoastră, întrebați un vânzător specializat.

EN Check that wall anchors provided are suitable for your wall (those provided in the package are for concrete). Otherwise, use screws and wall anchors suited to the type of material of your wall. To obtain advice on the screws and fittings suited to your wall, ask a specialized sales assistant.

2



3M

Assemble with this side, with easy clean treatment, on the inside.

İze karışı işleminde tabii tutulmuş bu yüzü iç tarafa doğru konumlanmalıdır.

Cette face, avec un traitement facilement nettoyable, doit être positionnée vers l'intérieur.

Esta cara está tratada para facilitar su limpieza y se debe colocar hacia el interior.

Esta face com tratamento para facilitar a limpeza, deve ficar voltada para o interior.

Questo lato, deve essere posizionato con il trattamento easy clean all'interno.

Эта сторона, обработанная средством против образования накипи, должна быть обращена вовнутрь.

Сторона, оброблена засобом проти накипу, повинна бути звернена всередину.

Această față, tratată pentru curățare ușoară, trebuie poziționată spre interior.

Strona z powłoką zapewniającą łatwe czyszczenie powinna być skierowana do wewnątrz.

Αυτή η όψη, με επεξεργασία για εύκολο καθαρισμό, πρέπει να τοποθετηθεί προς το εσωτερικό.

V.7 2014



Attention danger / Atención: Peligro / Atencão perigo / Attenzione pericolo / Προσοχή κίνδυνος /
Uwaga niebezpieczeństwo / Внимание! Опасно! / Увага! Небезпечно! / Atenție, pericol / Caution danger



Correct / Correcto / Correcto / Corretto / Σωστό / Dobrze / Правильный /
Правильно / Corect / Correct



Incorrect / Incorrecto / Incorrecto / Errato / Λάθος / Žle / Неправильный /
Неправильно / Incorect / Incorrect

Notes / Observaciones / Notas / Note / Σημειώσεις / Notatki / Примечания / Примітки / Note / Notes

FR Préparation

ES Preparación

PT Preparação

IT Preparazione

EL Προετοιμασία

PL Przygotowanie

RU Подготовка

UK Підготування

RO Pregătire

EN Preparation

A

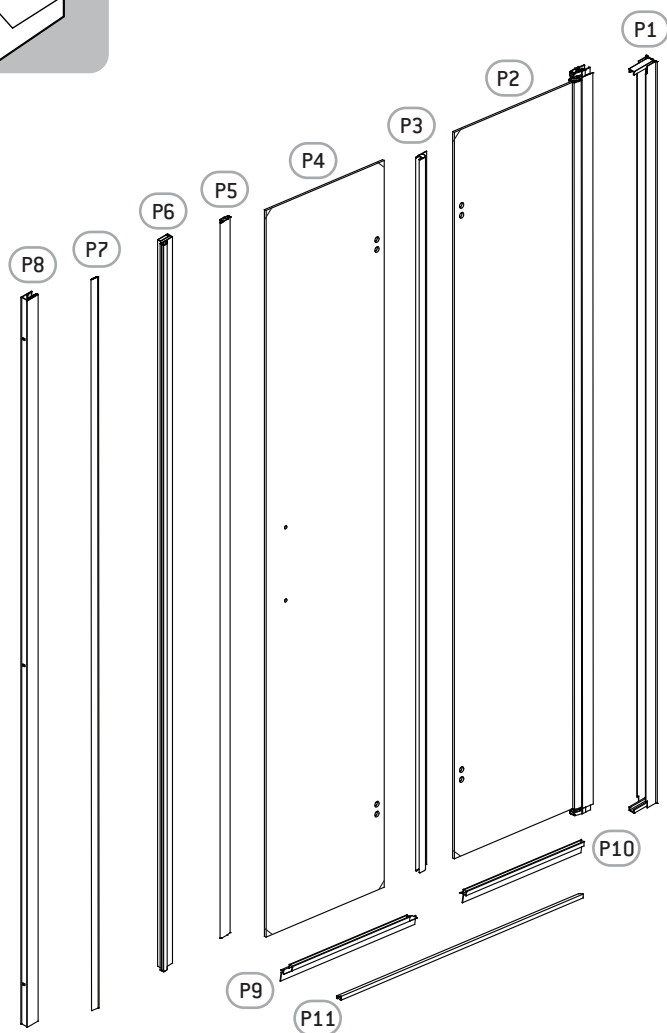
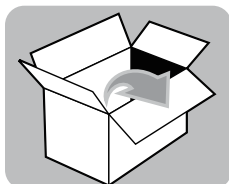

A

FR Préparation

ES Preparación

PT Preparação

IT Preparazione

EL Προετομασία

PL Przygotowanie

RU Подготовка

UK Підготування

RO Pregătire

EN Preparation

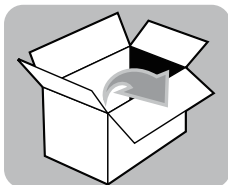

H1



x6

H2



x6

ST 4x40mm

H4



x1

H8



x1

H9



x1

H14



x1

H15



x1

H19



x2

H21



x1

H22



x1

H23

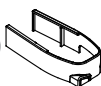

x1

H24



x1

3mm

H25



x8

H26



x2

H27



x1

4mm

H67



x2

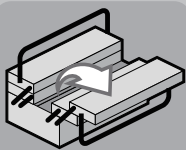

PH2



∅ 6mm

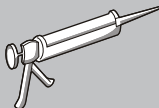
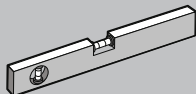
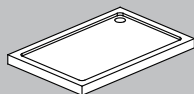
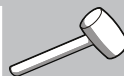

FR Montage

ES Montaje

PT Montagem

IT Montaggio

EL Συναρμολόγηση

PL Montaż

RU Сборка

UK Збірка

RO Montaj

EN Assembly

B

1

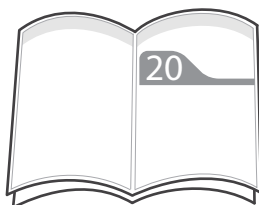
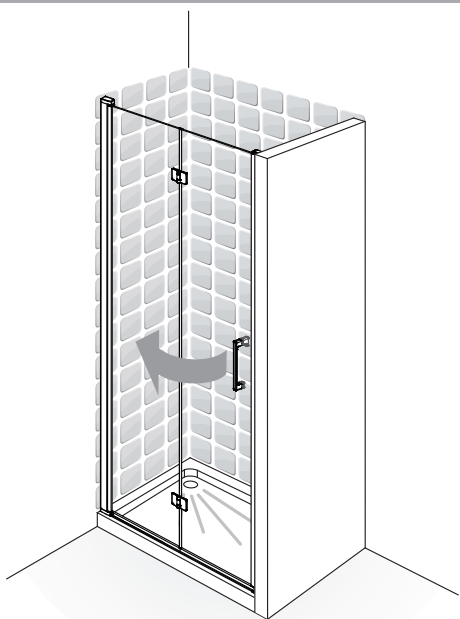
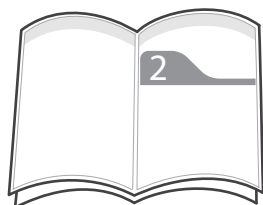
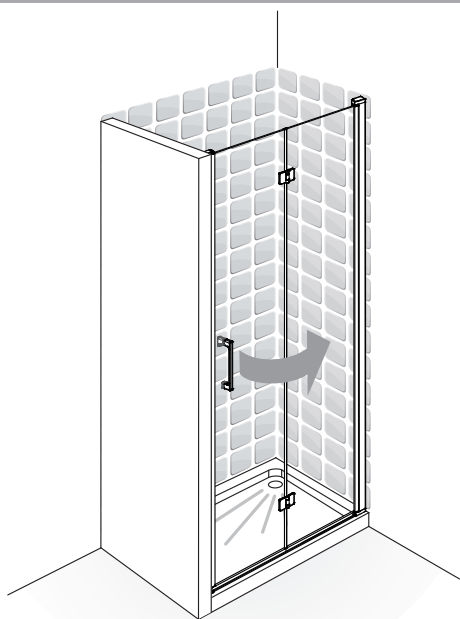

B

FR Montage

ES Montaje

PT Montagem

IT Montaggio

EL Συναρμολόγηση

PL Montaż

RU Сборка

UK Збірка

RO Montaj

EN Assembly

2

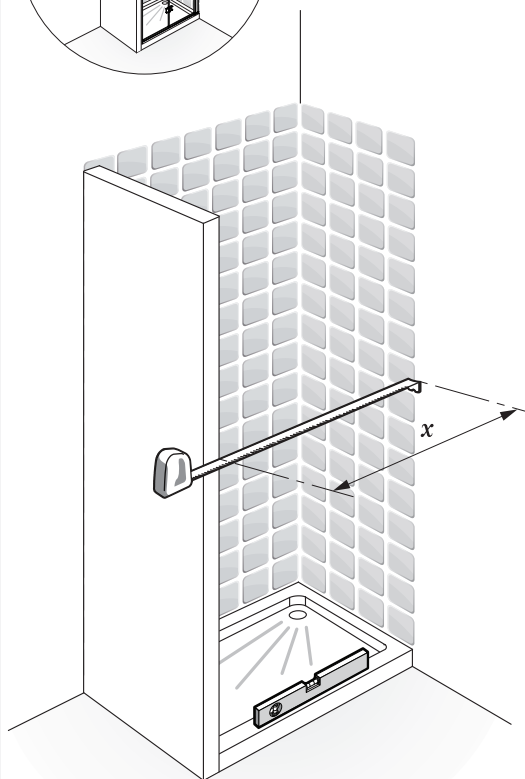
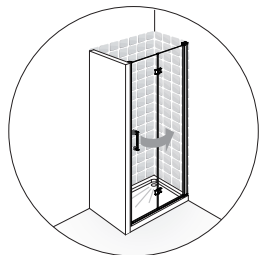

REMIX	X(mm)
700mm	675 - 705
800mm	775 - 805
900mm	875 - 905
1000mm	975 - 1005

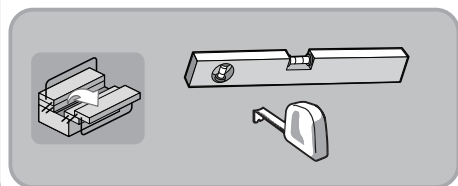
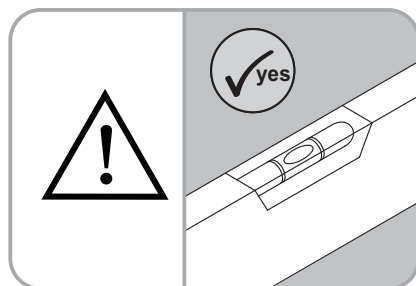

FR Montage

ES Montaje

PT Montagem

IT Montaggio

EL Συναρμολόγηση

PL Montaż

RU Сборка

UK Збірка

RO Montaj

EN Assembly

B

3

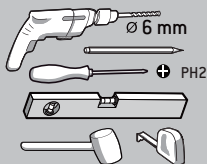
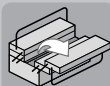
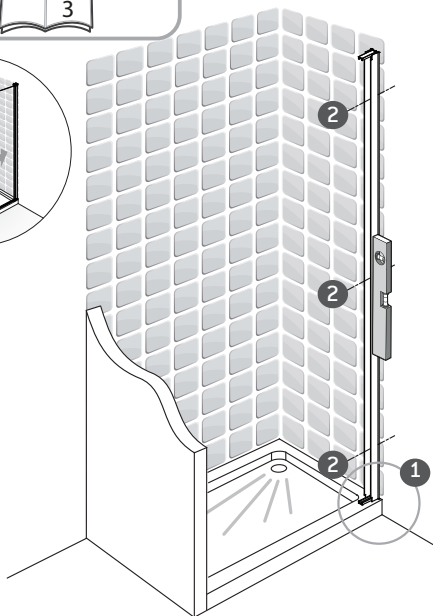
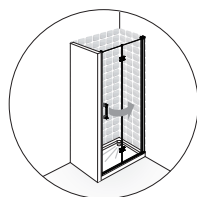
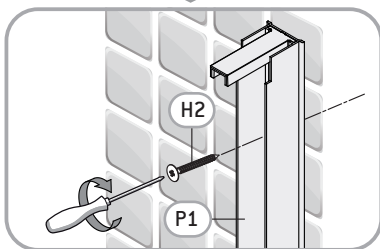
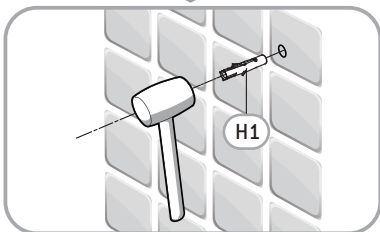
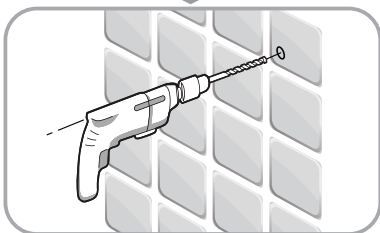
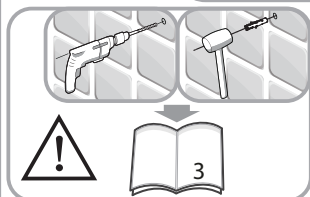
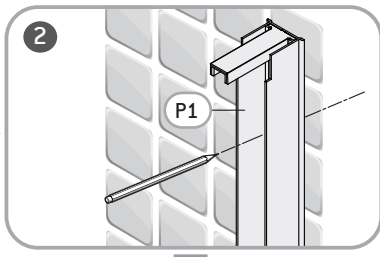
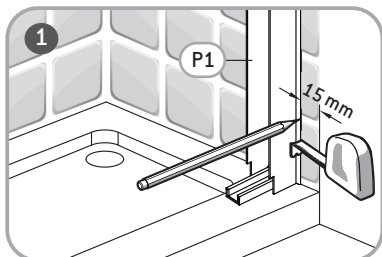

H1



x3

H2



x3

ST 4x40mm

P1

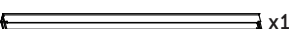

x1



B

FR Montage

ES Montaje

PT Montagem

IT Montaggio

EL Συναρμολόγηση

PL Montaż

RU Сборка

UK Збірка

RO Montaj

EN Assembly

4

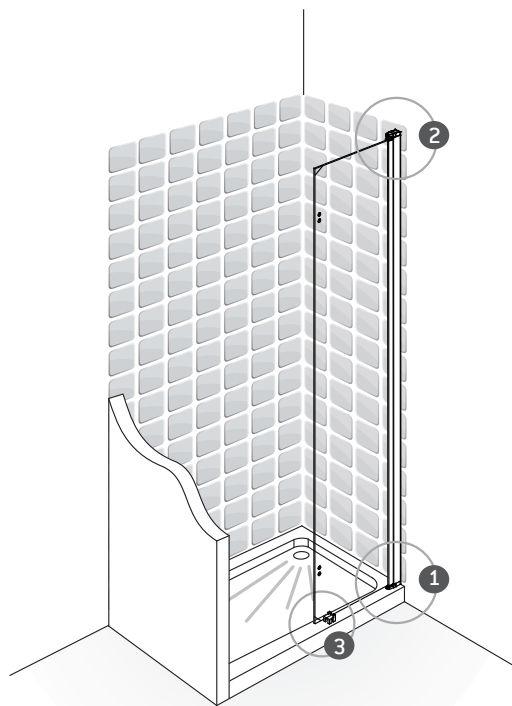
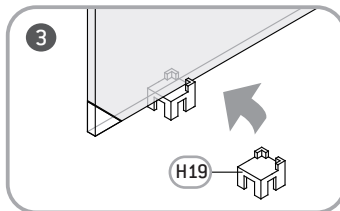
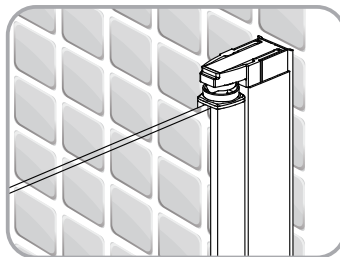
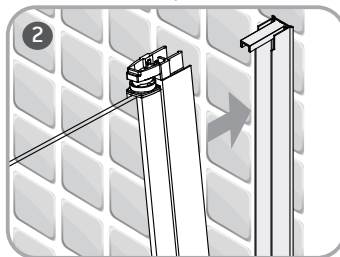
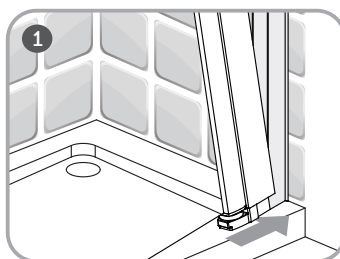
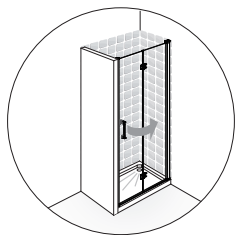

P2



H19



FR Montage

ES Montaje

PT Montagem

IT Montaggio

EL Συναρμολόγηση

PL Montaż

RU Сборка

UK Збірка

RO Montaj

EN Assembly

B

5

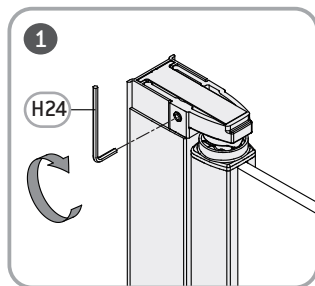
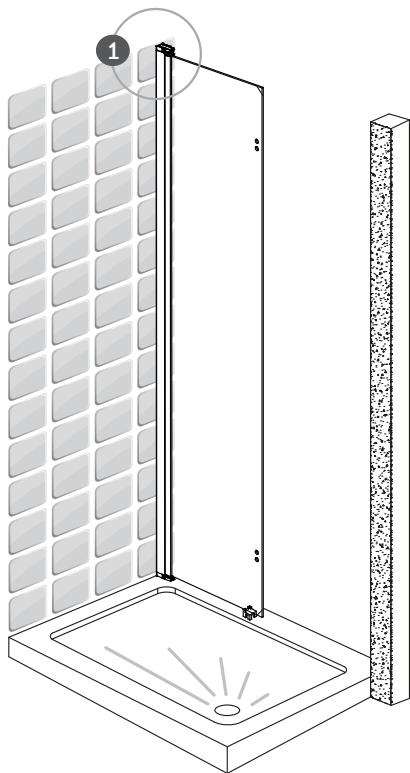
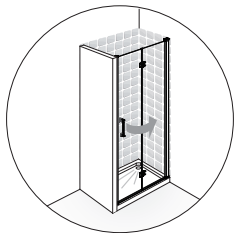

H24



x1

3mm



B

FR Montage

ES Montaje

PT Montagem

IT Montaggio

EL Συναρμολόγηση

PL Montaż

RU Сборка

UK Збірка

RO Montaj

EN Assembly

6

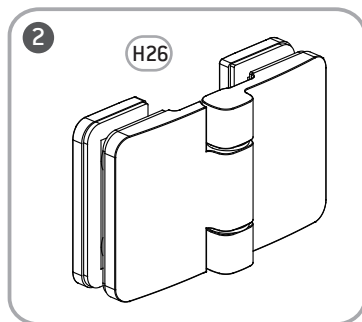
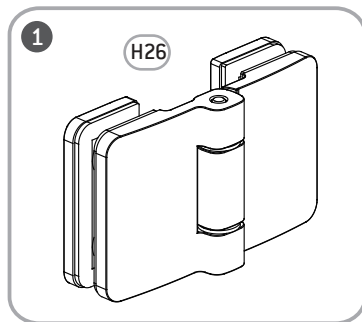
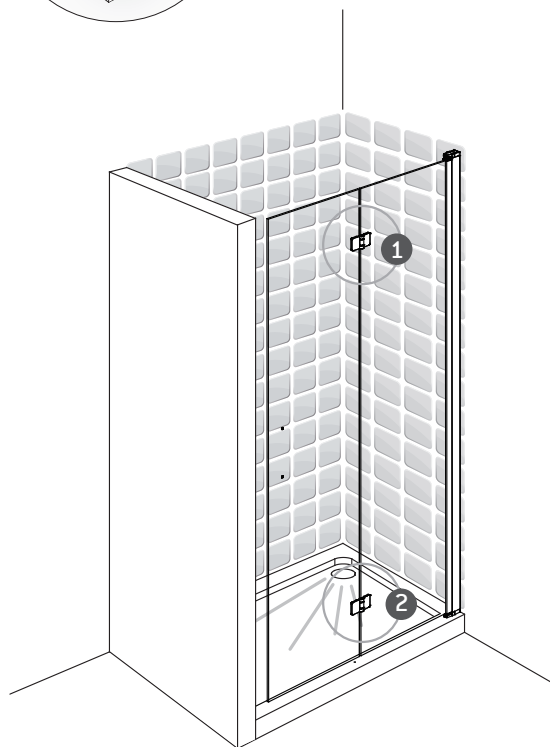
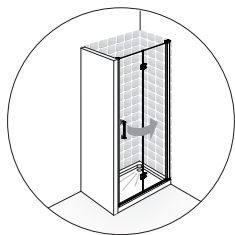

H26

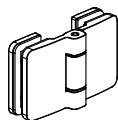

x2



FR Montage

ES Montaje

PT Montagem

IT Montaggio

EL Συναρμολόγηση

PL Montaż

RU Сборка

UK Збірка

RO Montaj

EN Assembly

B

7

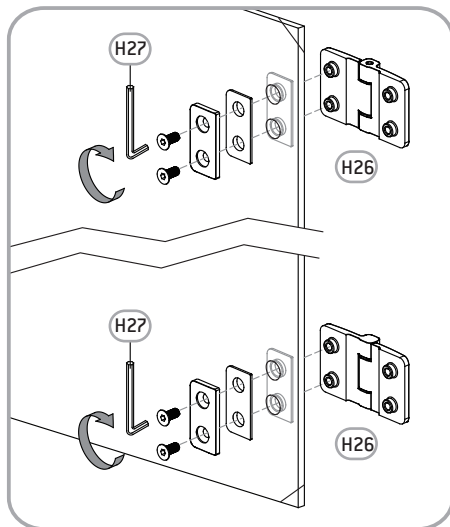
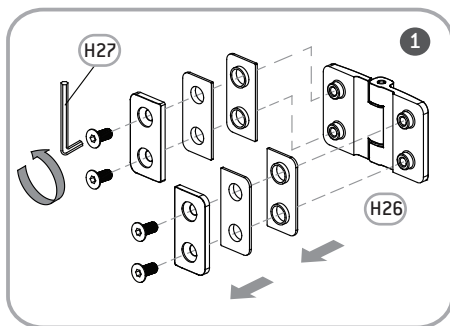
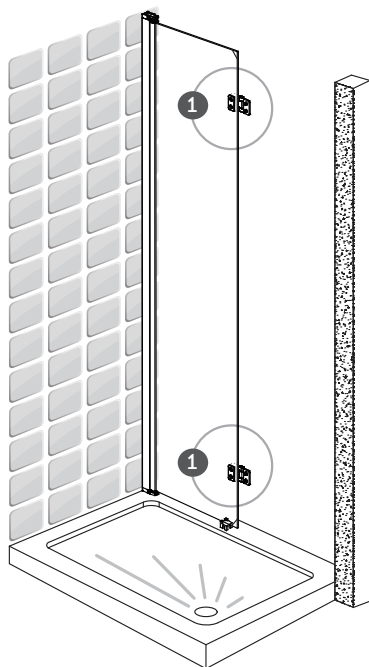
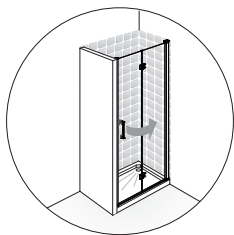

H26

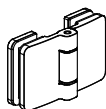

x2

H27



4mm

x1



B

FR Montage

ES Montaje

PT Montagem

IT Montaggio

EL Συναρμολόγηση

PL Montaż

RU Сборка

UK Збірка

RO Montaj

EN Assembly

8

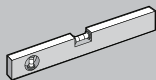
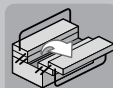
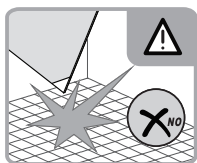
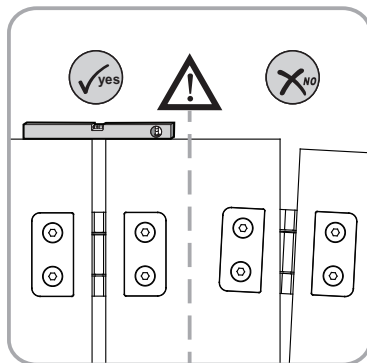
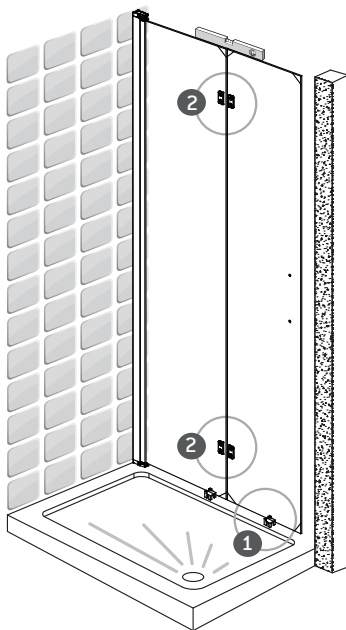
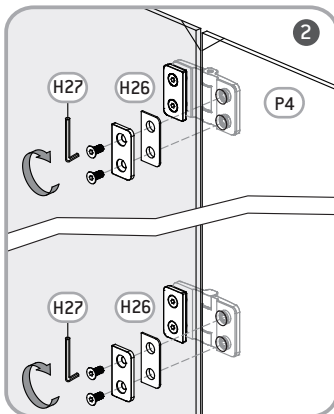
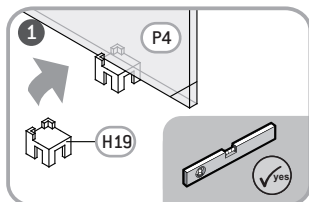

P4

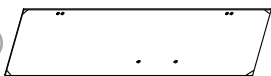

x1

H27

x1

4mm

H19



x1



x4



x2

x4



FR Montage

ES Montaje

PT Montagem

IT Montaggio

EL Συναρμολόγηση

PL Montaż

RU Сборка

UK Збірка

RO Montaj

EN Assembly

B

9

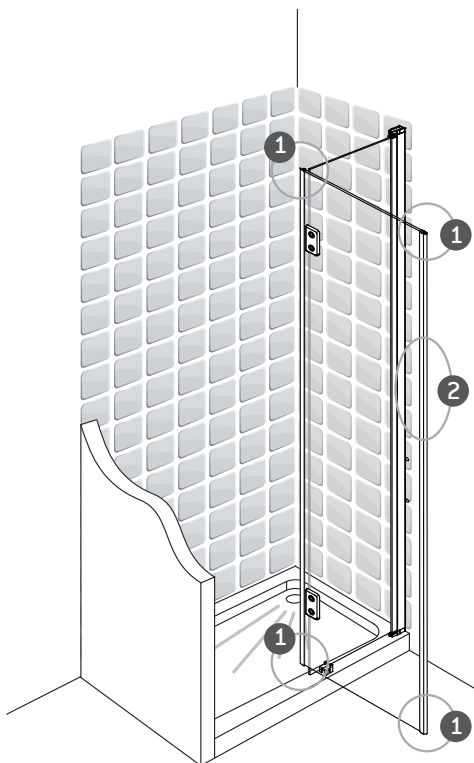
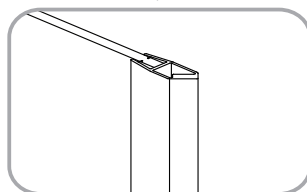
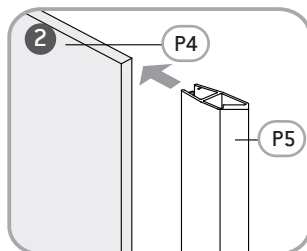
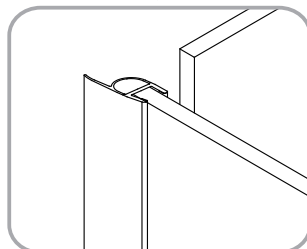
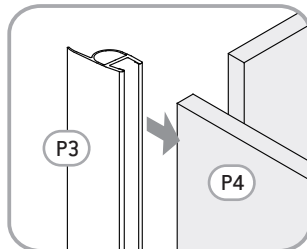
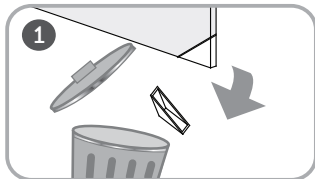
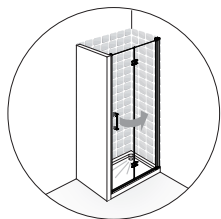

P3



x1

P5



x1



B

FR Montage

ES Montaje

PT Montagem

IT Montaggio

EL Συναρμολόγηση

PL Montaż

RU Сборка

UK Збірка

RO Montaj

EN Assembly

10

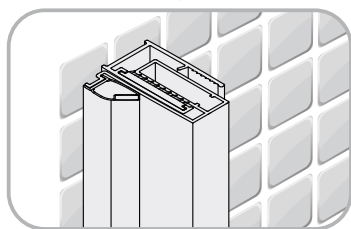
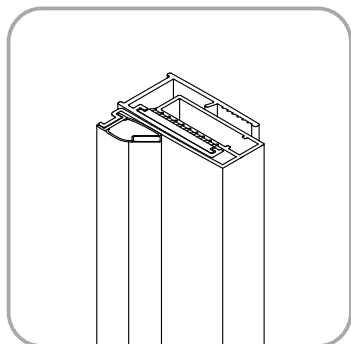
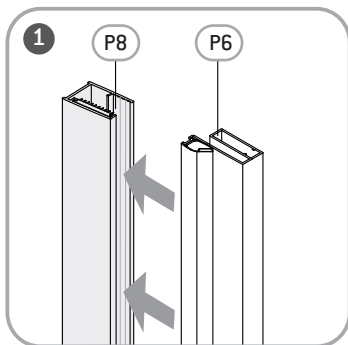
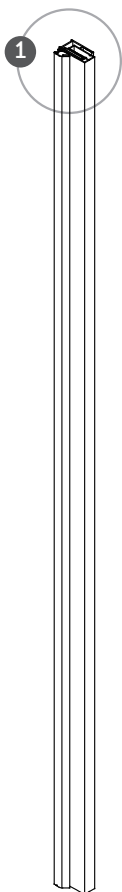
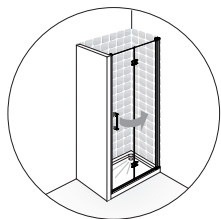

P6



x1

P8

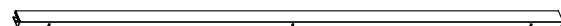

x1



FR Montage

ES Montaje

PT Montagem

IT Montaggio

EL Συναρμολόγηση

PL Montaż

RU Сборка

UK Збірка

RO Montaj

EN Assembly

B

11

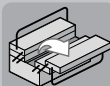
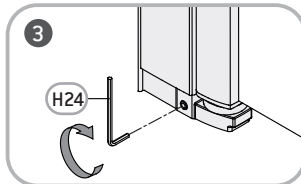
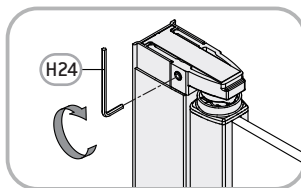
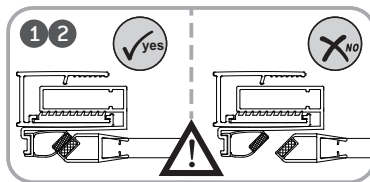
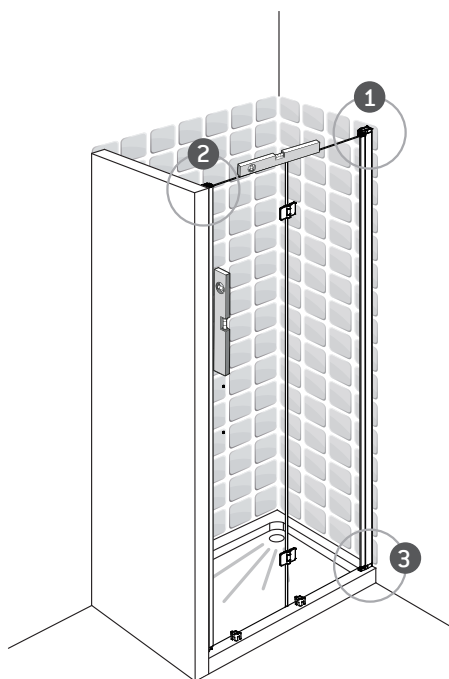
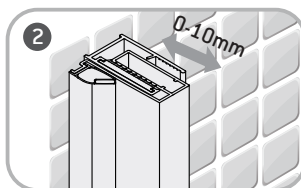
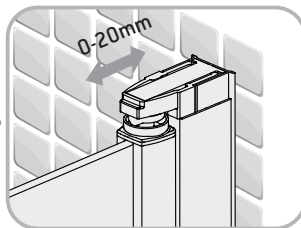
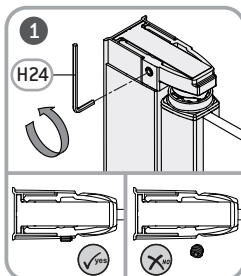
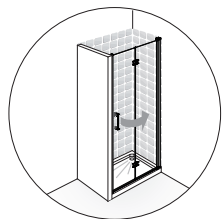

H24

x1



3mm



B

FR Montage

ES Montaje

PT Montagem

IT Montaggio

EL Συναρμολόγηση

PL Montaż

RU Сборка

UK Збірка

RO Montaj

EN Assembly

12

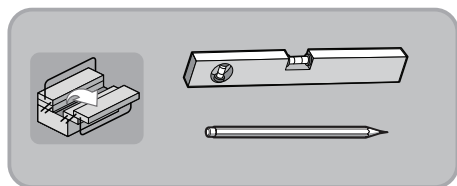
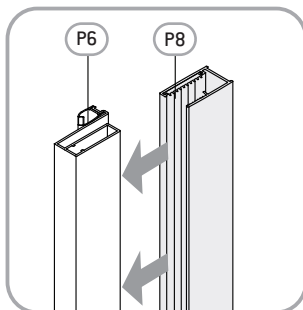
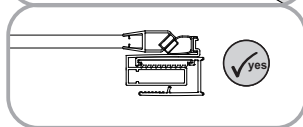
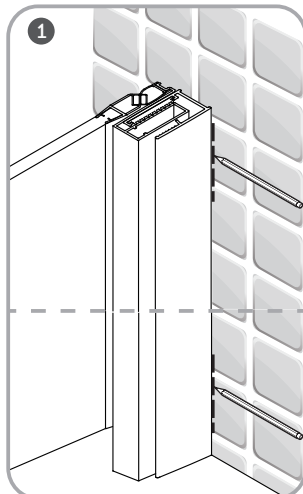
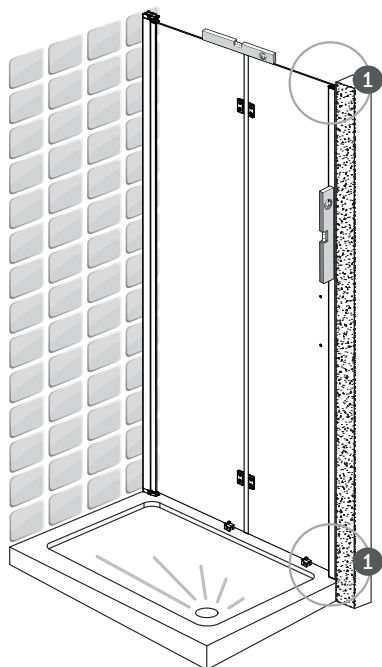

FR Montage

ES Montaje

PT Montagem

IT Montaggio

EL Συναρμολόγηση

PL Montaż

RU Сборка

UK Збірка

RO Montaj

EN Assembly

B

13

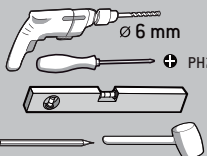
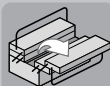
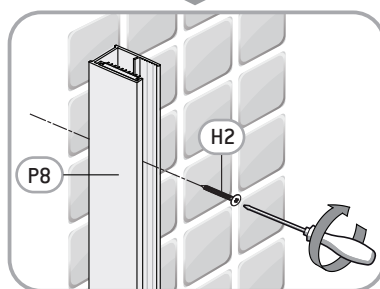
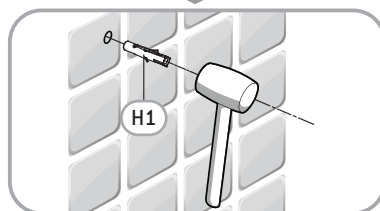
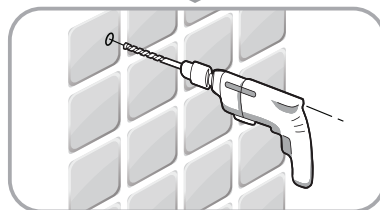
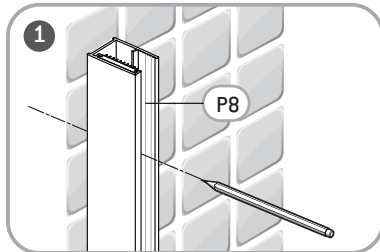
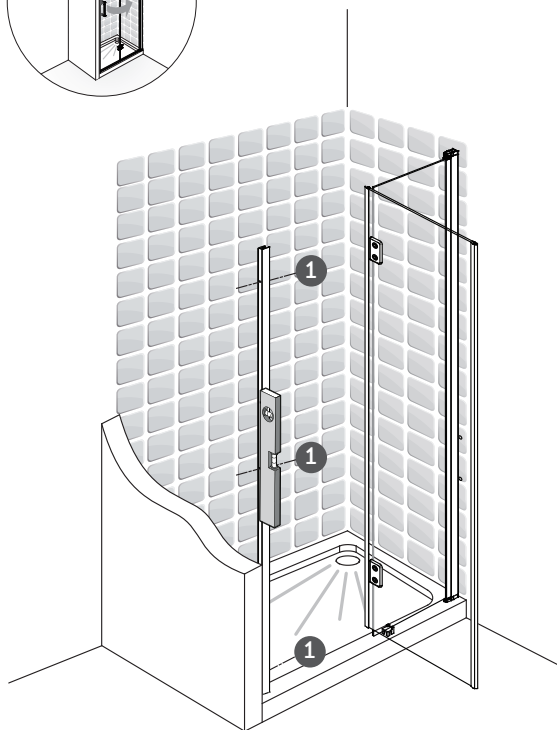
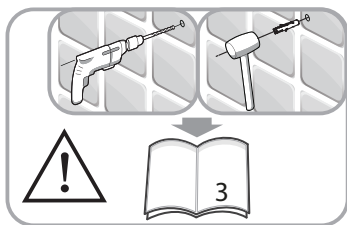

H1



x3

H2



x3

ST 4x40mm

P8

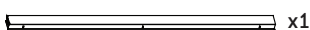

x1



B

FR Montage

ES Montaje

PT Montagem

IT Montaggio

EL Συναρμολόγηση

PL Montaż

RU Сборка

UK Збірка

RO Montaj

EN Assembly

14

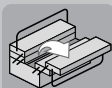
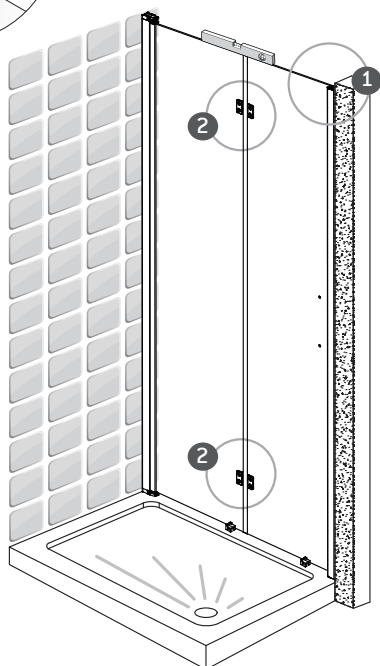
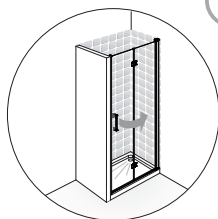
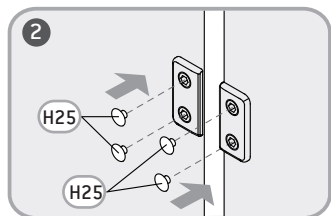
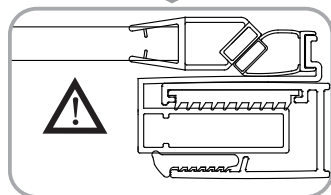
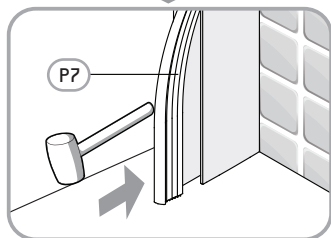
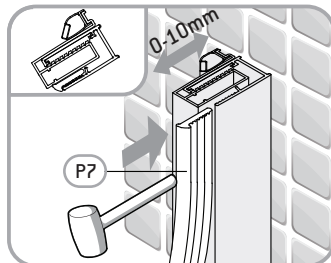
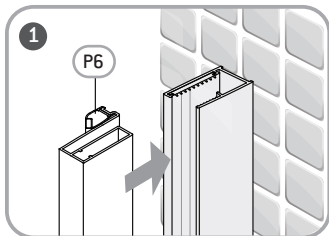

P6



x1

P7



x1

H25



x8



FR Montage

ES Montaje

PT Montagem

IT Montaggio

EL Συναρμολόγηση

PL Montaż

RU Сборка

UK Збірка

RO Montaj

EN Assembly

B

15

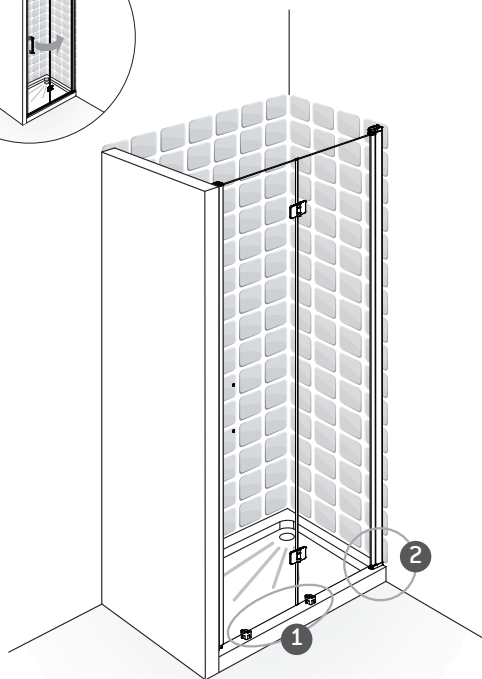
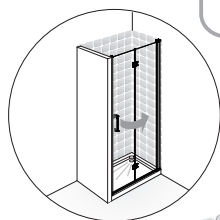
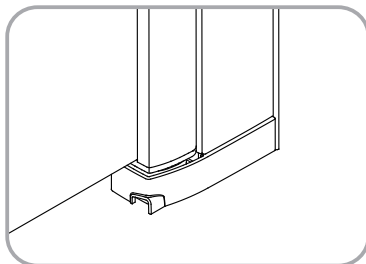
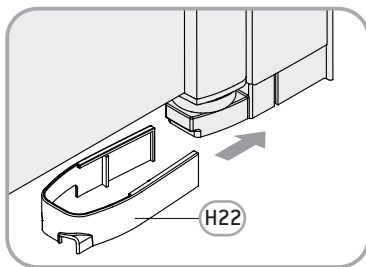
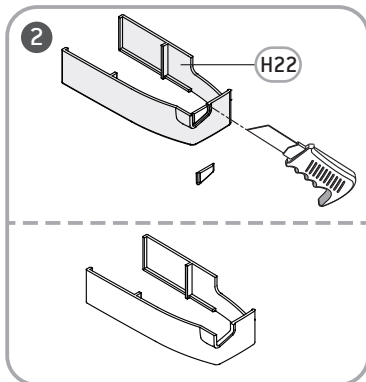
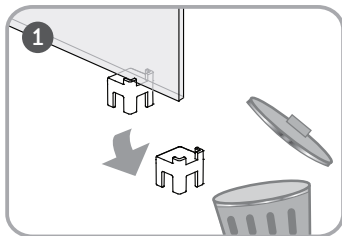

H22

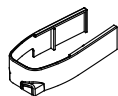

x1



B

FR Montage

ES Montaje

PT Montagem

IT Montaggio

EL Συναρμολόγηση

PL Montaż

RU Сборка

UK Збірка

RO Montaj

EN Assembly

16

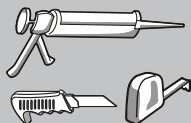
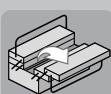
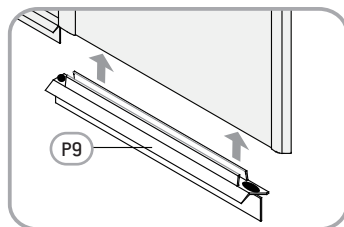
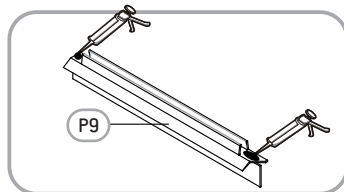
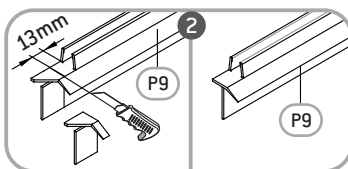
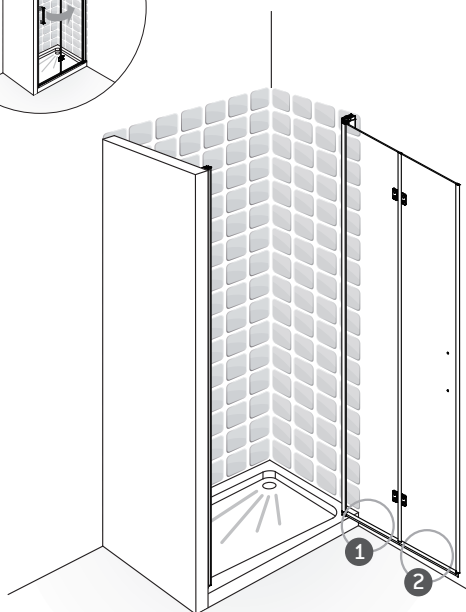
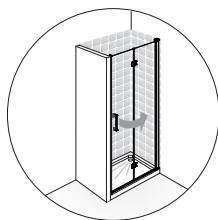
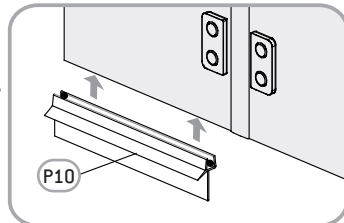
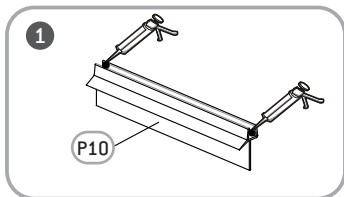

P9

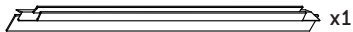

P10



FR Montage

ES Montaje

PT Montagem

IT Montaggio

EL Συναρμολόγηση

PL Montaż

RU Сборка

UK Збірка

RO Montaj

EN Assembly

B

17

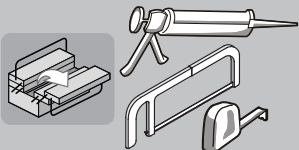
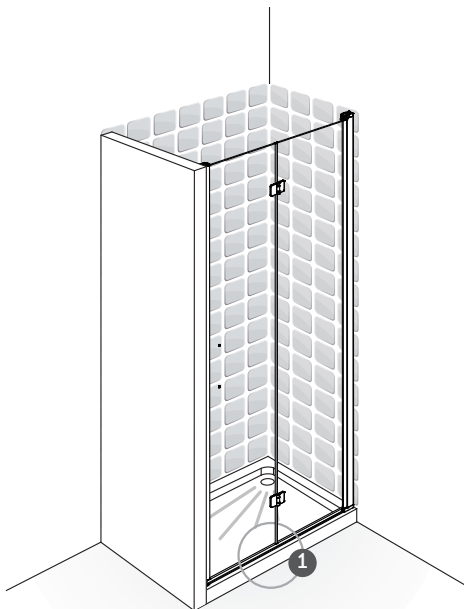
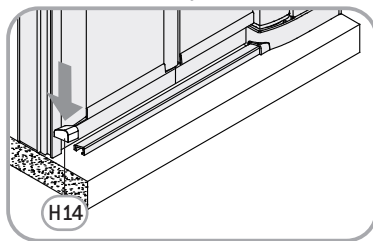
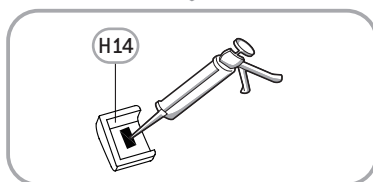
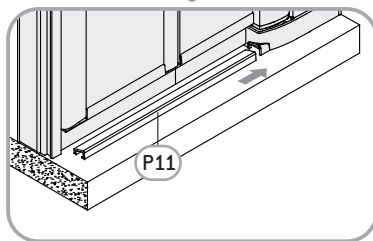
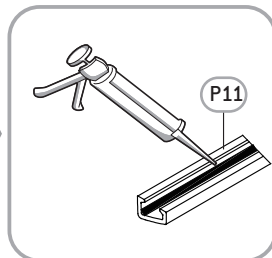
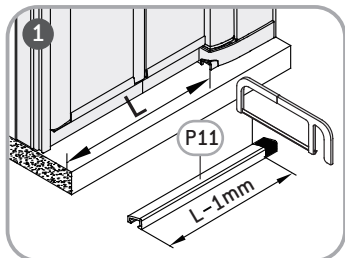
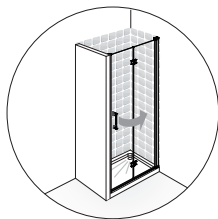

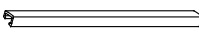
P11  x1

H14  x1



B

FR Montage

ES Montaje

PT Montagem

IT Montaggio

EL Συναρμολόγηση

PL Montaż

RU Сборка

UK Збірка

RO Montaj

EN Assembly

18

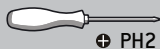
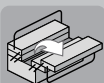
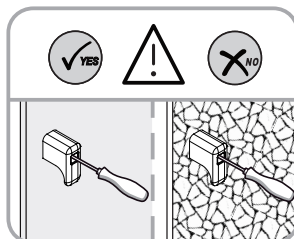
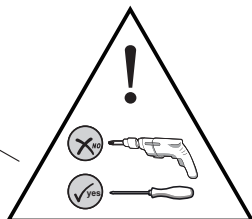
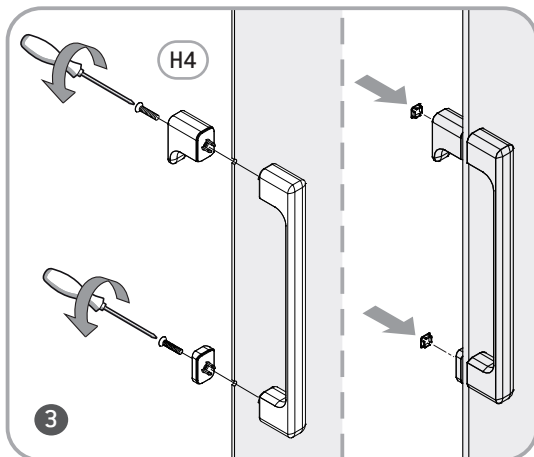
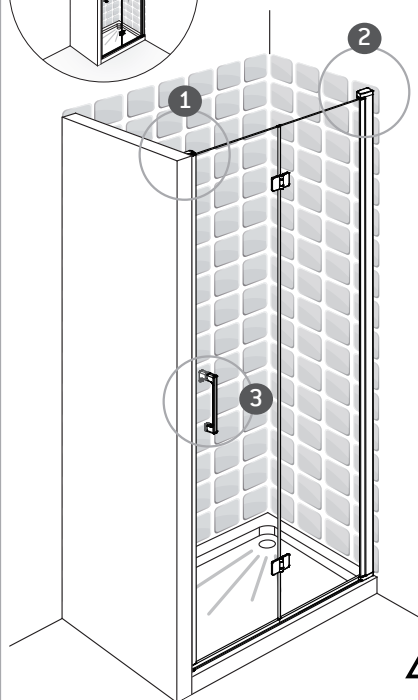
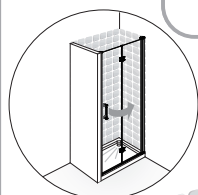
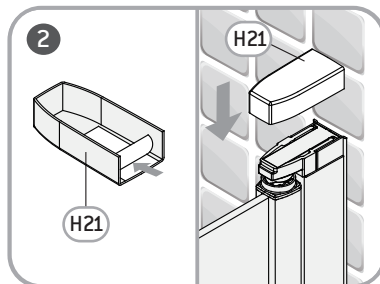
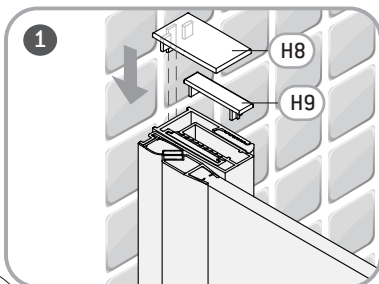

+ PH2

H4



x1

H21

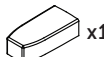

x1

H8

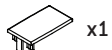

x1

H9



x1



FR Montage

ES Montaje

PT Montagem

IT Montaggio

EL Συναρμολόγηση

PL Montaż

RU Сборка

UK Збірка

RO Montaj

EN Assembly

B

19

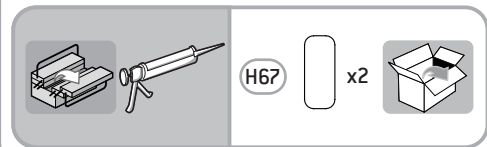
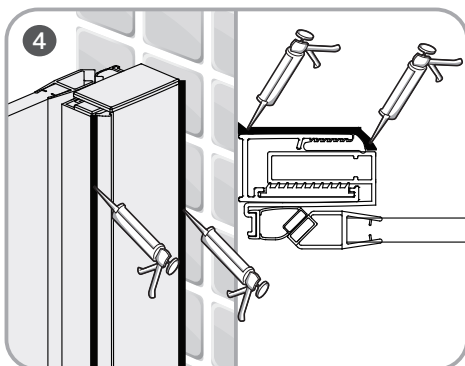
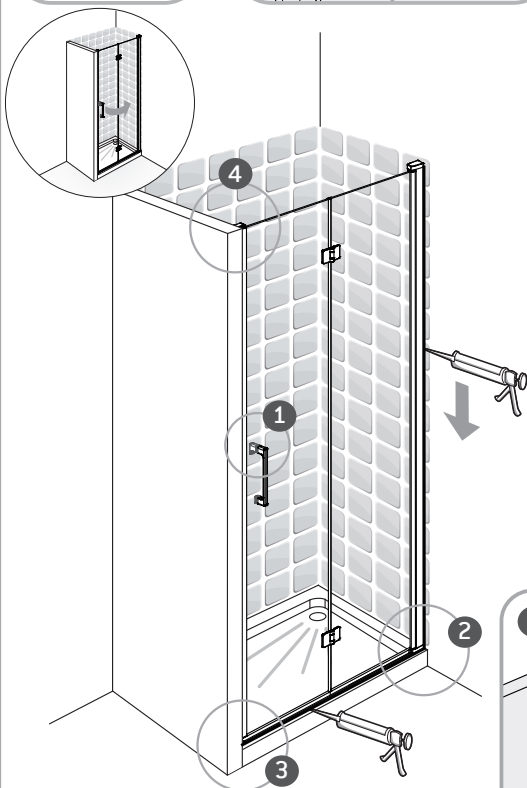
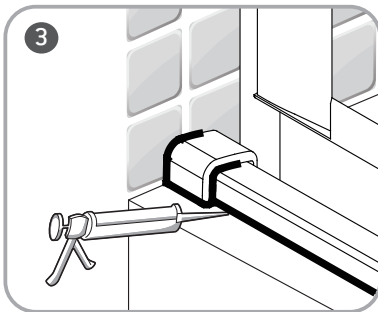
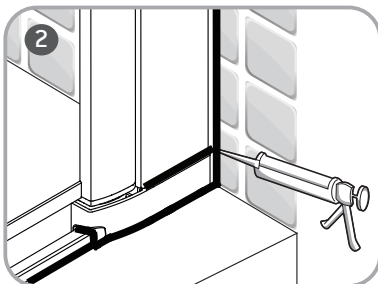
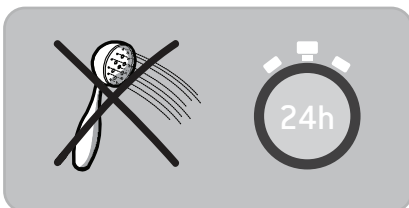
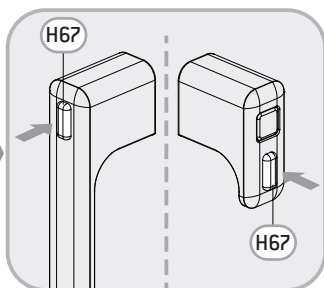
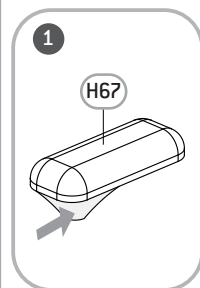

B

FR Montage

ES Montaje

PT Montagem

IT Montaggio

EL Συναρμολόγηση

PL Montaż

RU Сборка

UK Збірка

RO Montaj

EN Assembly

20

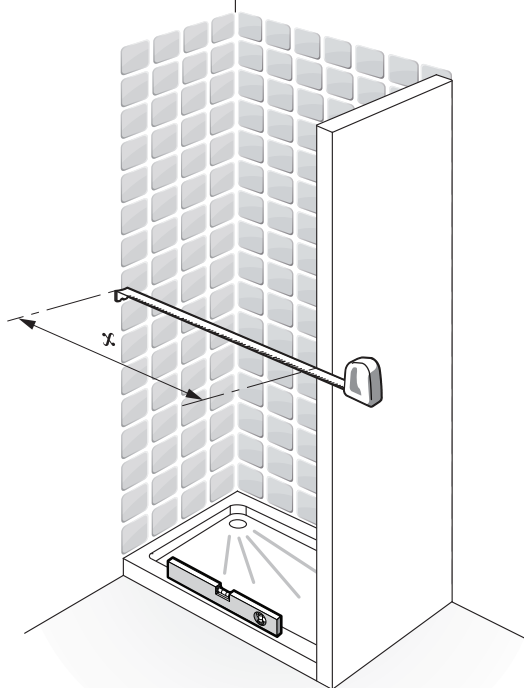
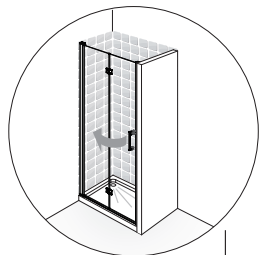

REMIX	X(mm)
700mm	675 - 705
800mm	775 - 805
900mm	875 - 905
1000mm	975 - 1005

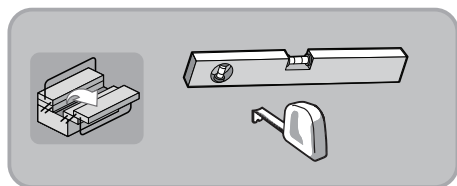
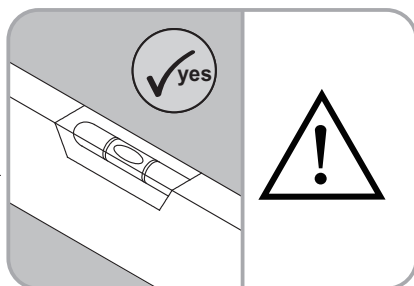

FR Montage

ES Montaje

PT Montagem

IT Montaggio

EL Συναρμολόγηση

PL Montaż

RU Сборка

UK Збірка

RO Montaj

EN Assembly

B

21

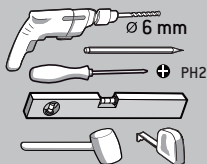
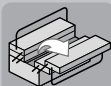
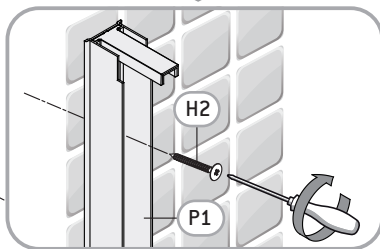
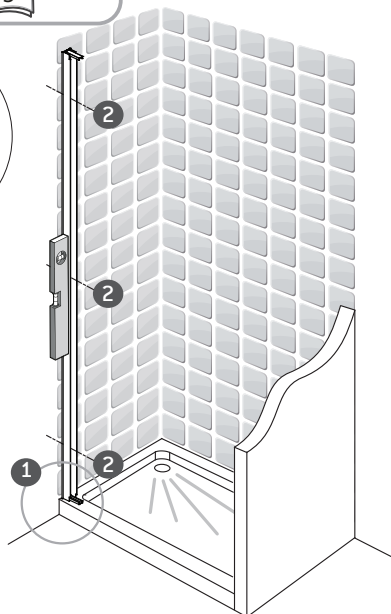
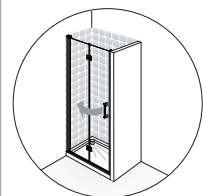
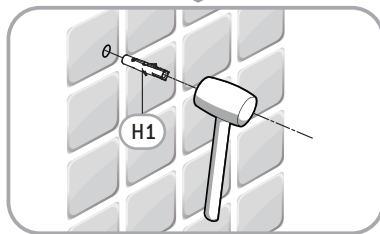
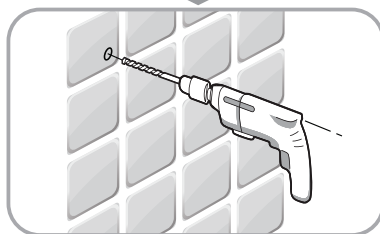
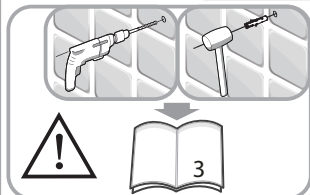
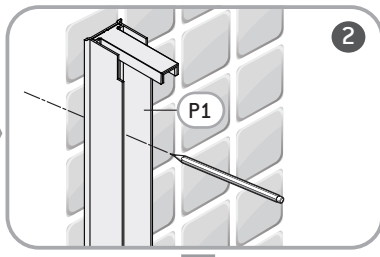
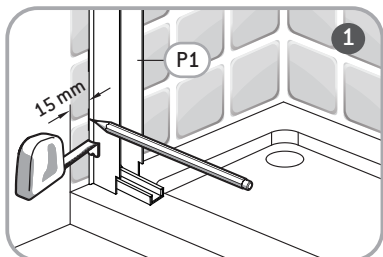

H1



H2



ST 4x40mm

P1

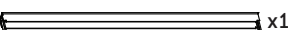

B

FR Montage

ES Montaje

PT Montagem

IT Montaggio

EL Συναρμολόγηση

PL Montaż

RU Сборка

UK Збірка

RO Montaj

EN Assembly

22

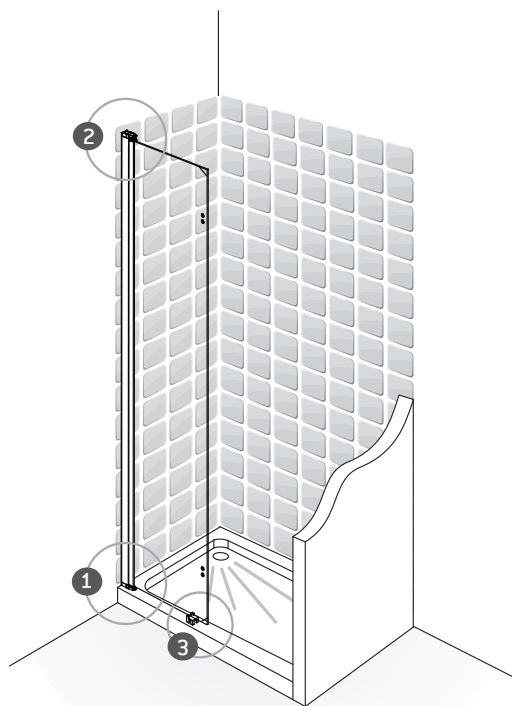
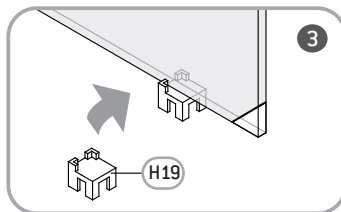
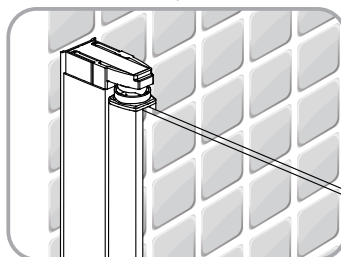
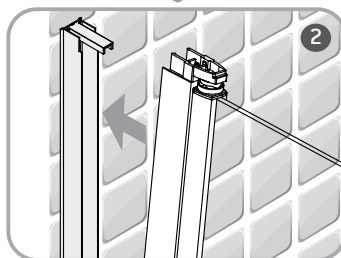
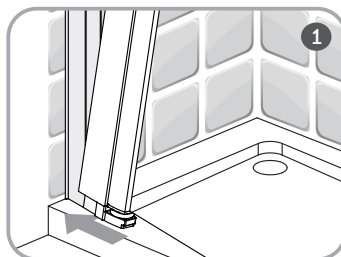
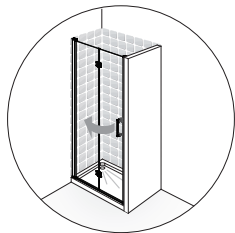

P2



x1

H19



x1



FR Montage

ES Montaje

PT Montagem

IT Montaggio

EL Συναρμολόγηση

PL Montaż

RU Сборка

UK Збірка

RO Montaj

EN Assembly

B

23

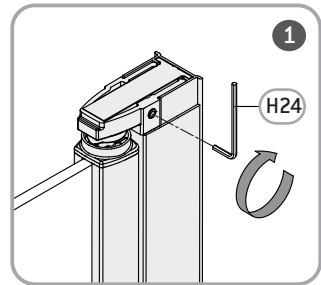
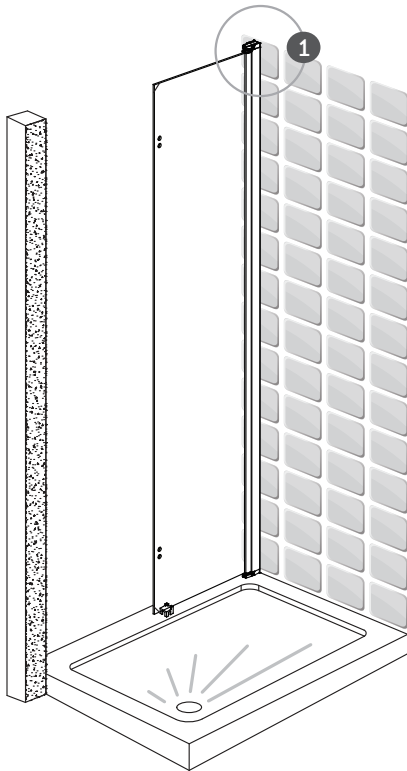
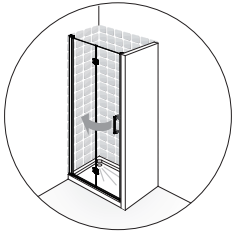

H24



x1

3mm



B

FR Montage

ES Montaje

PT Montagem

IT Montaggio

EL Συναρμολόγηση

PL Montaż

RU Сборка

UK Збірка

RO Montaj

EN Assembly

24

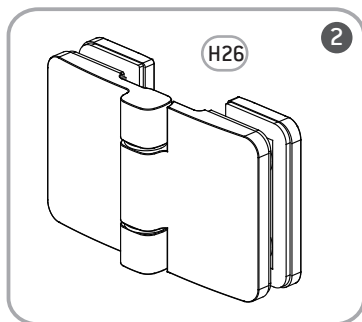
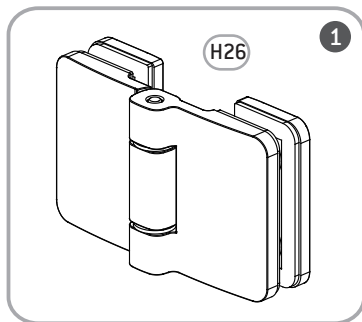
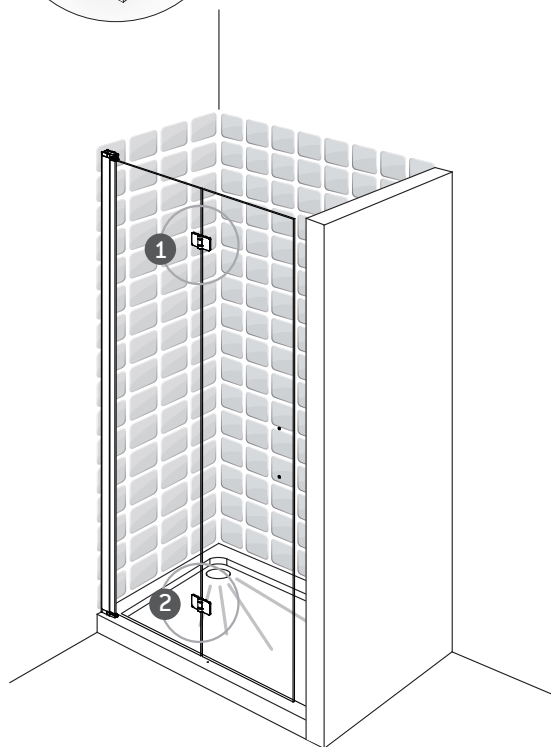
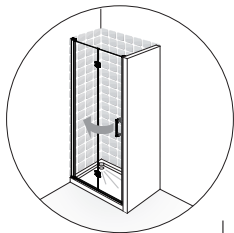

H26

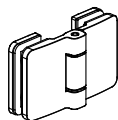

x2



FR Montage

ES Montaje

PT Montagem

IT Montaggio

EL Συναρμολόγηση

PL Montaż

RU Сборка

UK Збірка

RO Montaj

EN Assembly

B

25

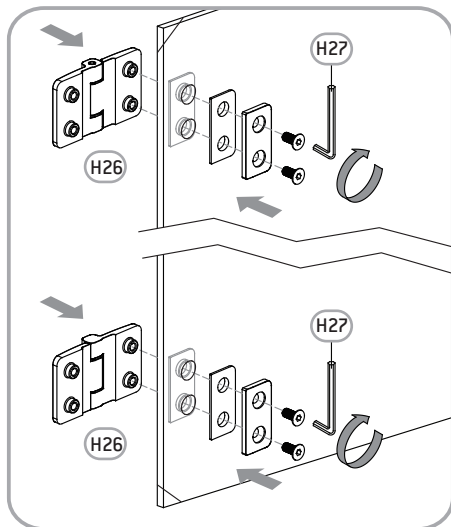
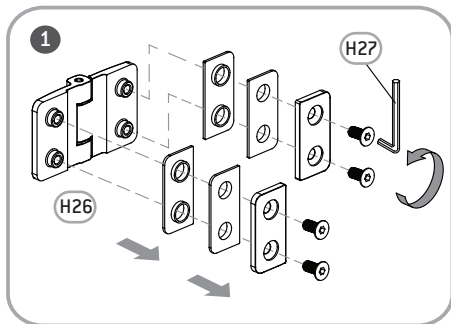
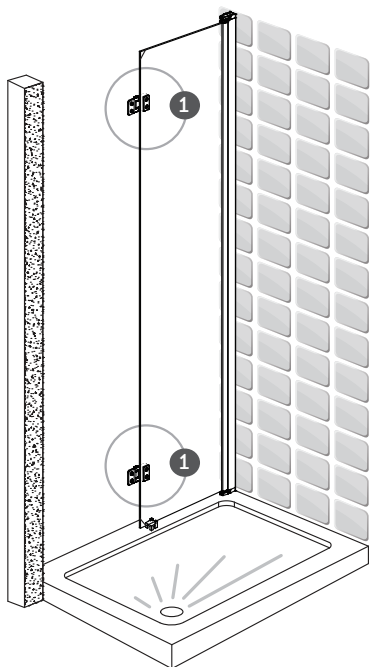
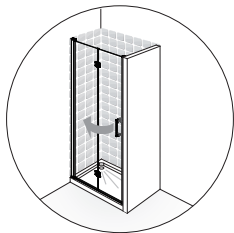

H26

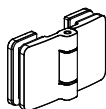

x2

H27



x1



B

FR Montage

ES Montaje

PT Montagem

IT Montaggio

EL Συναρμολόγηση

PL Montaż

RU Сборка

UK Збірка

RO Montaj

EN Assembly

26

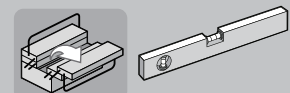
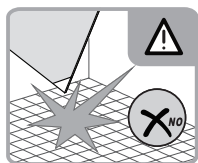
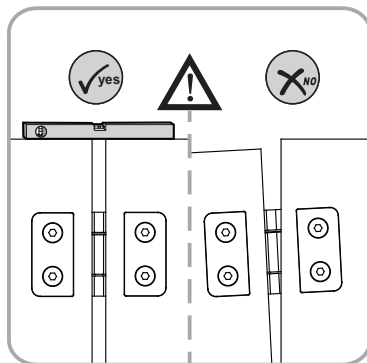
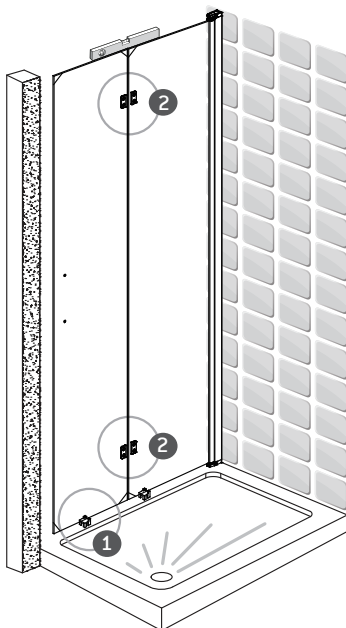
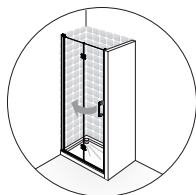
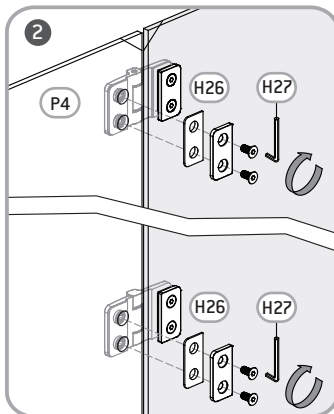
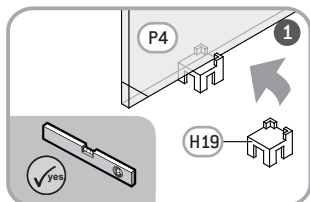

P4

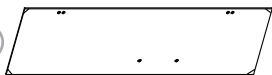

x1

H27



x1

4mm

H19



x1



x4



x2



x4



FR Montage

ES Montaje

PT Montagem

IT Montaggio

EL Συναρμολόγηση

PL Montaż

RU Сборка

UK Збірка

RO Montaj

EN Assembly

B

27

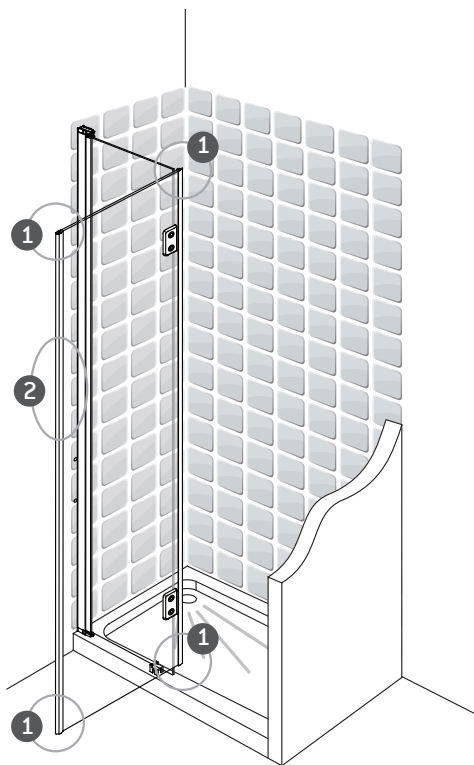
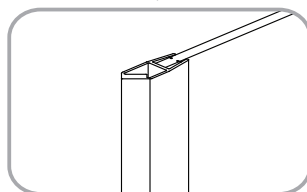
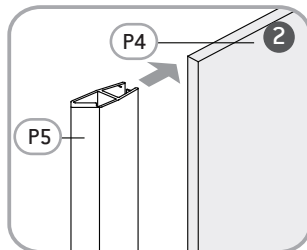
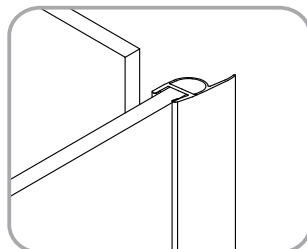
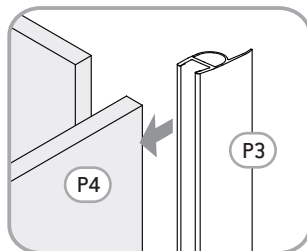
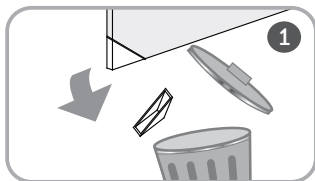
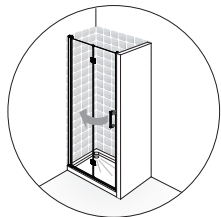

P3



x1

P5



x1



B

FR Montage

ES Montaje

PT Montagem

IT Montaggio

EL Συναρμολόγηση

PL Montaż

RU Сборка

UK Збірка

RO Montaj

EN Assembly

28

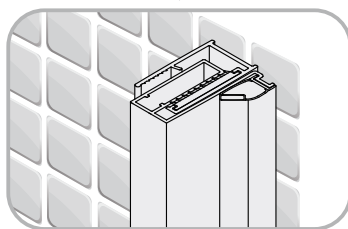
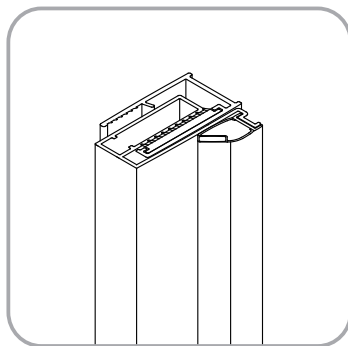
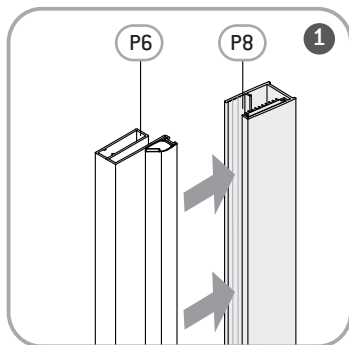
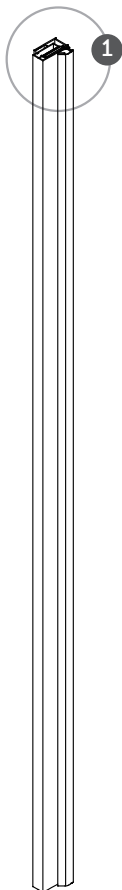
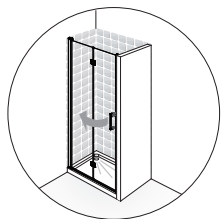

P6



x1

P8



x1



FR Montage

ES Montaje

PT Montagem

IT Montaggio

EL Συναρμολόγηση

PL Montaż

RU Сборка

UK Збірка

RO Montaj

EN Assembly

B

29

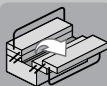
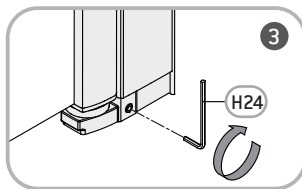
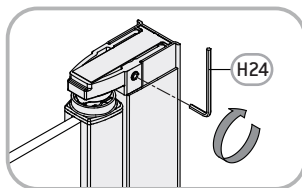
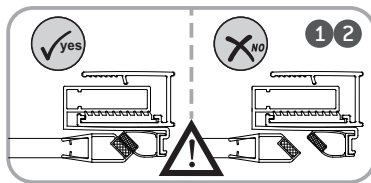
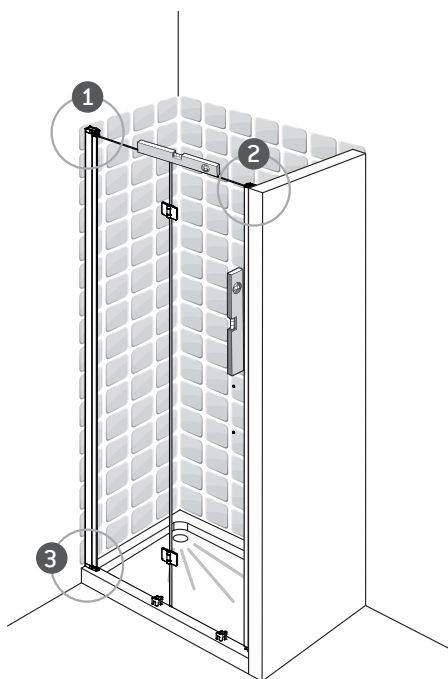
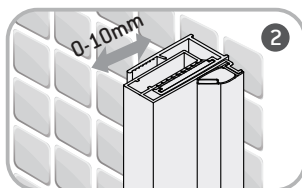
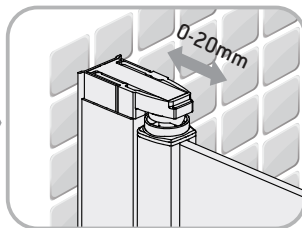
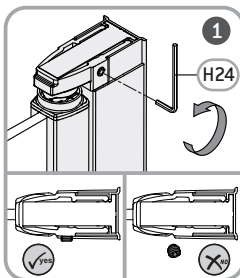
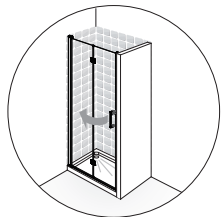

H24

x1



3mm



B

FR Montage

ES Montaje

PT Montagem

IT Montaggio

EL Συναρμολόγηση

PL Montaż

RU Сборка

UK Збірка

RO Montaj

EN Assembly

30

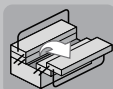
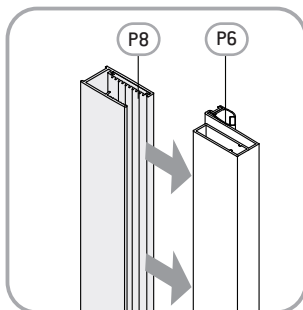
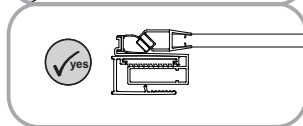
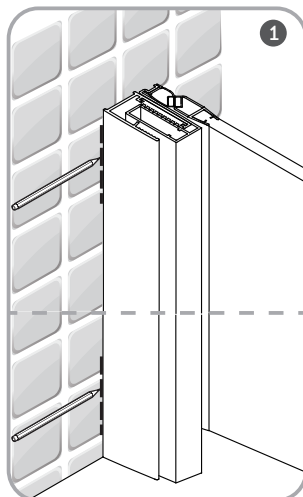
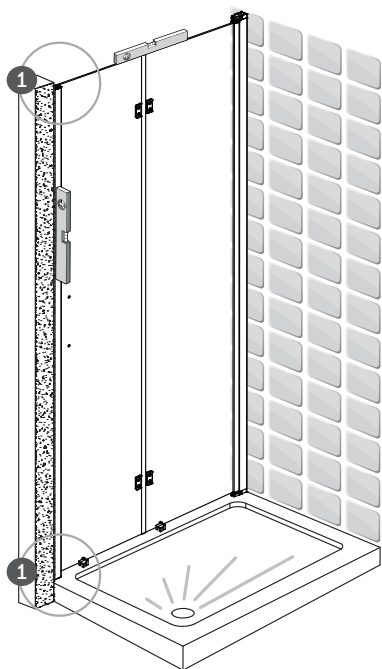
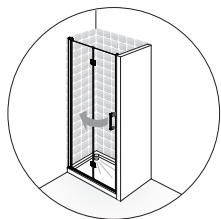

FR Montage

ES Montaje

PT Montagem

IT Montaggio

EL Συναρμολόγηση

PL Montaż

RU Сборка

UK Збірка

RO Montaj

EN Assembly

B

31

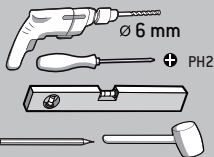
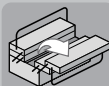
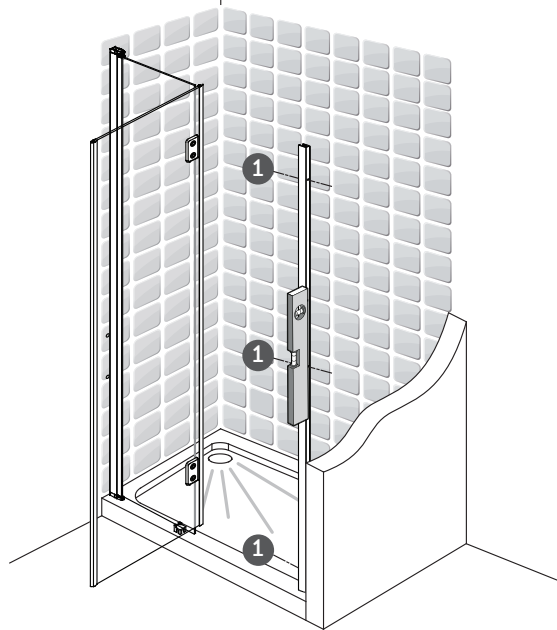
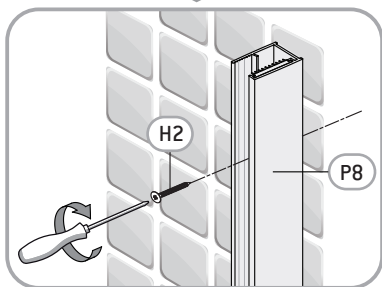
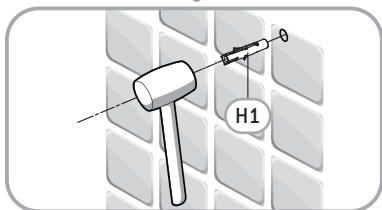
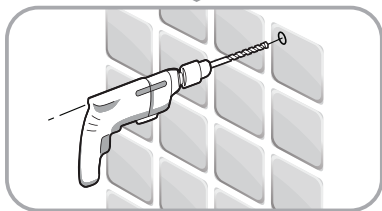
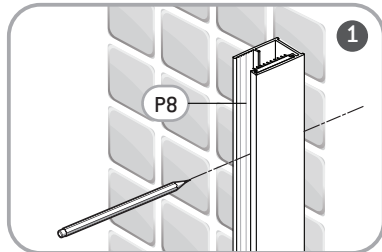
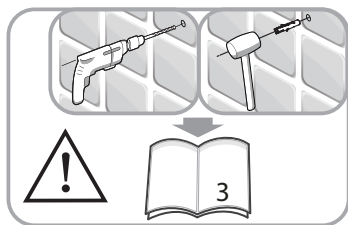

H1



H2

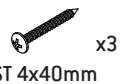

P8

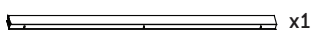

B

FR Montage

ES Montaje

PT Montagem

IT Montaggio

EL Συναρμολόγηση

PL Montaż

RU Сборка

UK Збірка

RO Montaj

EN Assembly

32

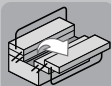
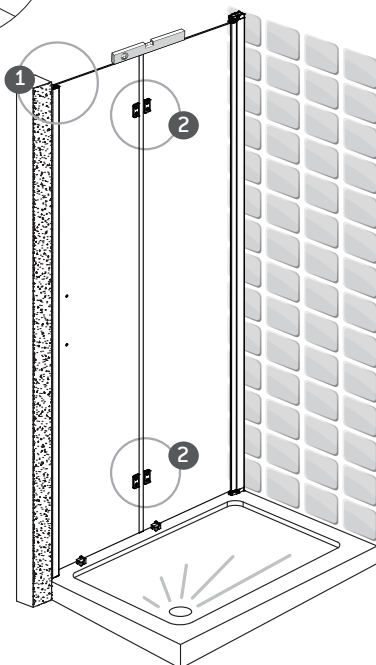
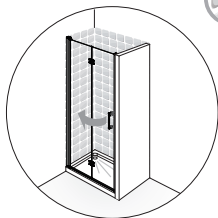
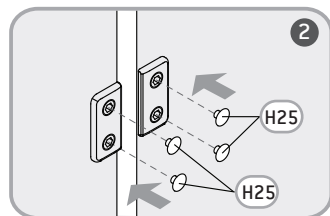
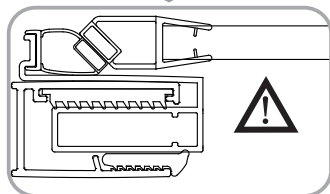
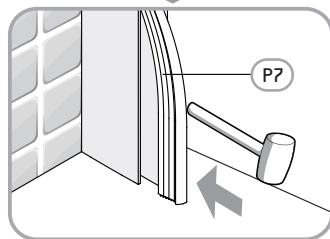
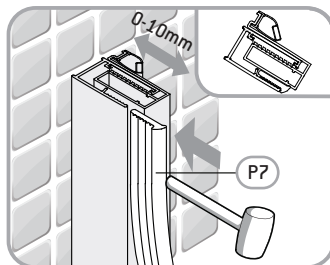
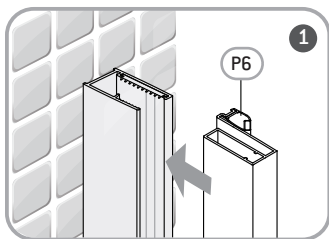

P6



x1

P7



x1

H25



x8



FR Montage

ES Montaje

PT Montagem

IT Montaggio

EL Συναρμολόγηση

PL Montaż

RU Сборка

UK Збірка

RO Montaj

EN Assembly

B

33

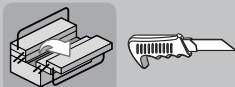
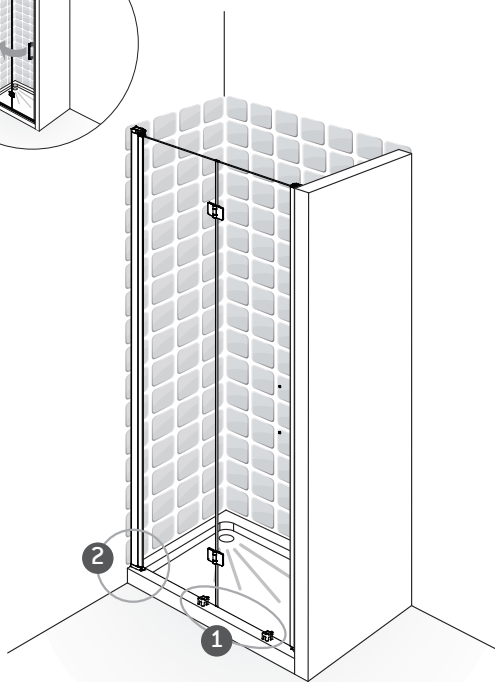
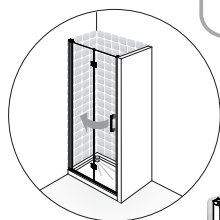
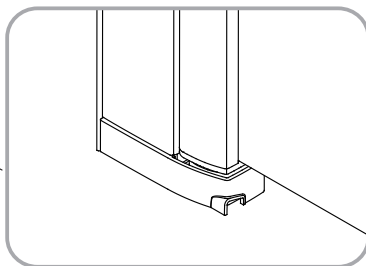
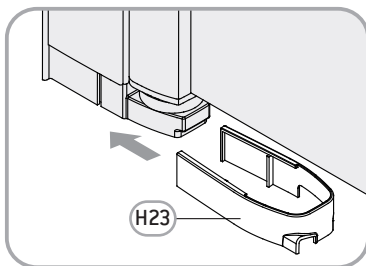
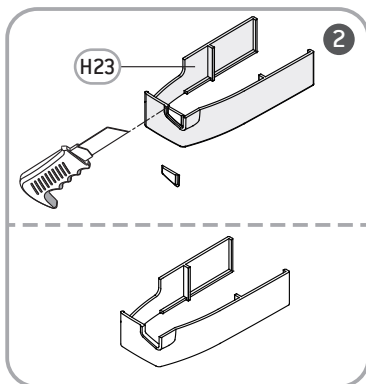
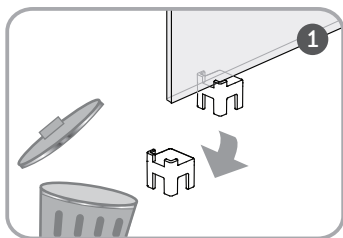

H23

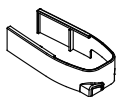

x1



B

FR Montage

ES Montaje

PT Montagem

IT Montaggio

EL Συναρμολόγηση

PL Montaż

RU Сборка

UK Збірка

RO Montaj

EN Assembly

34

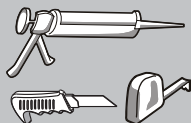
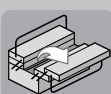
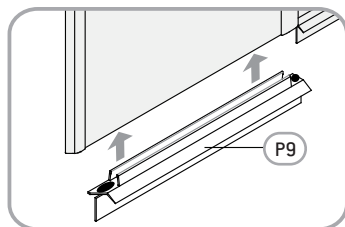
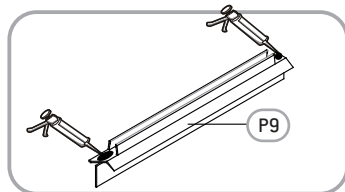
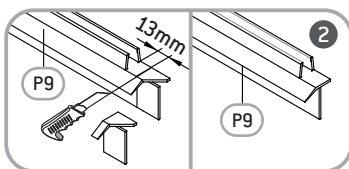
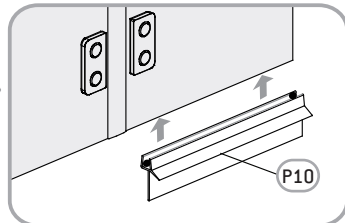
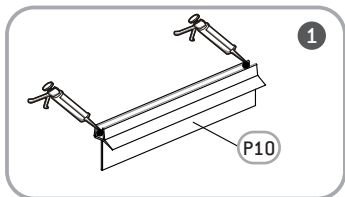
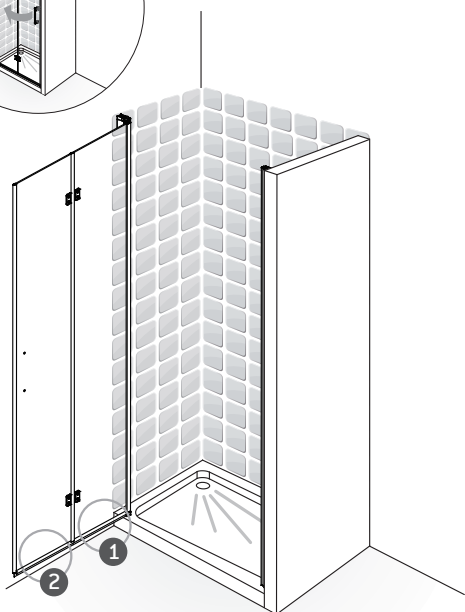
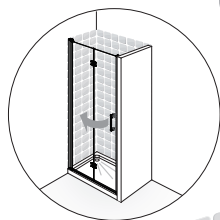

P9

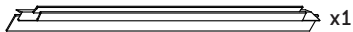

x1

P10



x1



FR Montage

ES Montaje

PT Montagem

IT Montaggio

EL Συναρμολόγηση

PL Montaż

RU Сборка

UK Збірка

RO Montaj

EN Assembly

B

35

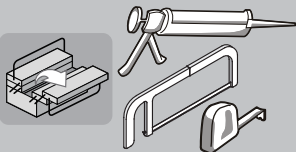
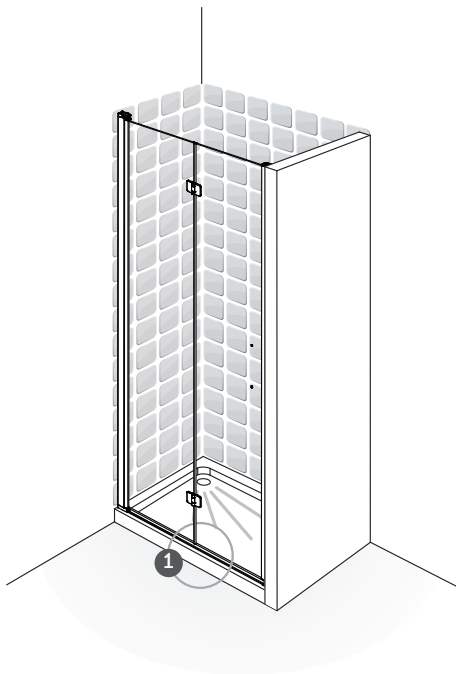
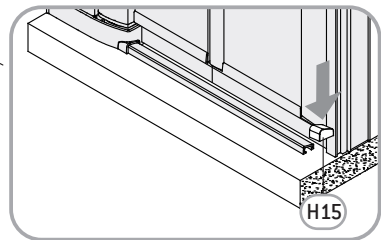
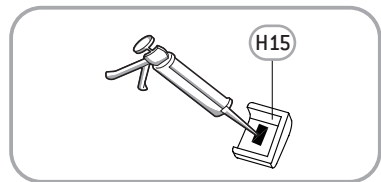
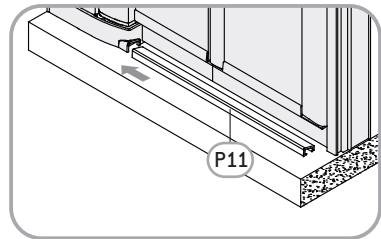
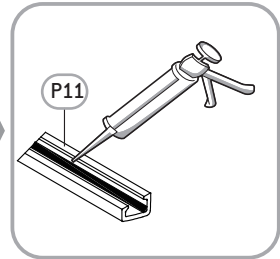
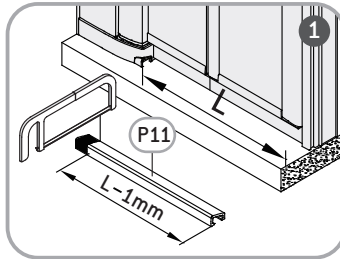
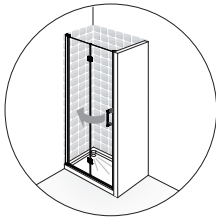

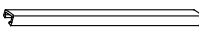
P11  x1

H15  x1



B

FR Montage

ES Montaje

PT Montagem

IT Montaggio

EL Συναρμολόγηση

PL Montaż

RU Сборка

UK Збірка

RO Montaj

EN Assembly

36

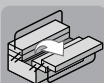
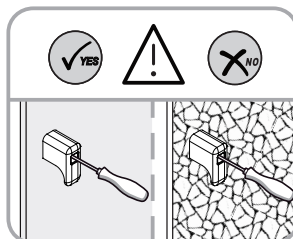
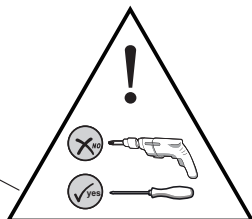
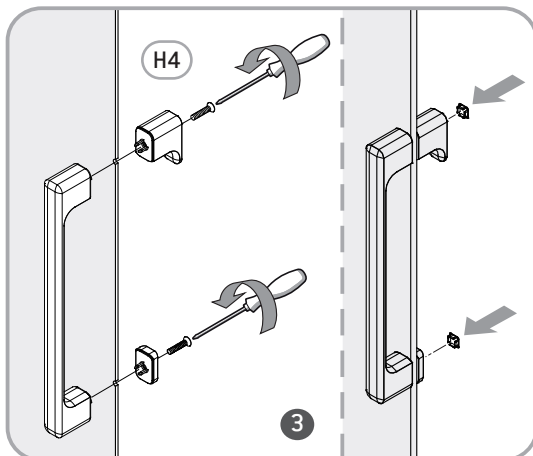
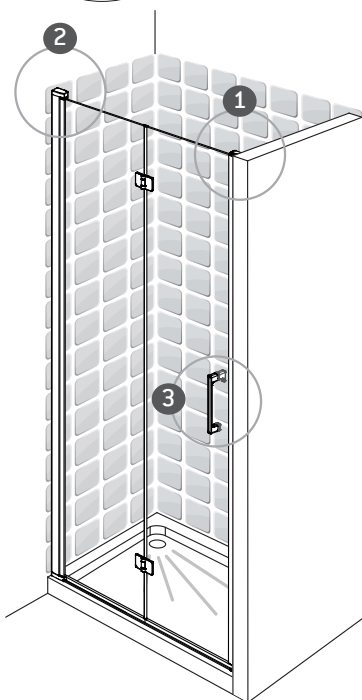
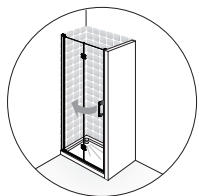
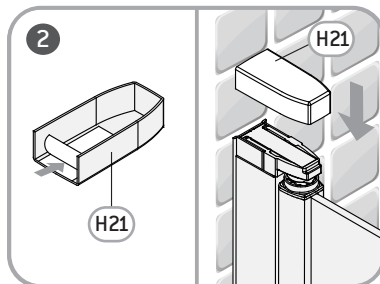
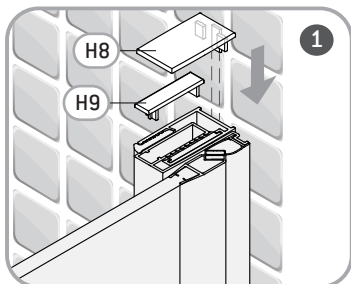

+ PH2

H4



x1

H21



x1

H8



x1

H9



x1



FR Montage

ES Montaje

PT Montagem

IT Montaggio

EL Συναρμολόγηση

PL Montaż

RU Сборка

UK Збірка

RO Montaj

EN Assembly

B

37

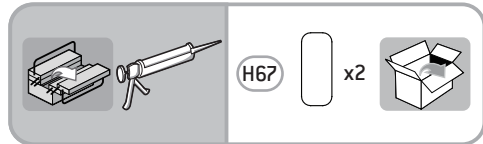
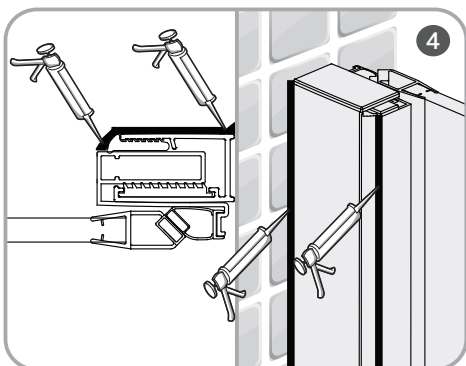
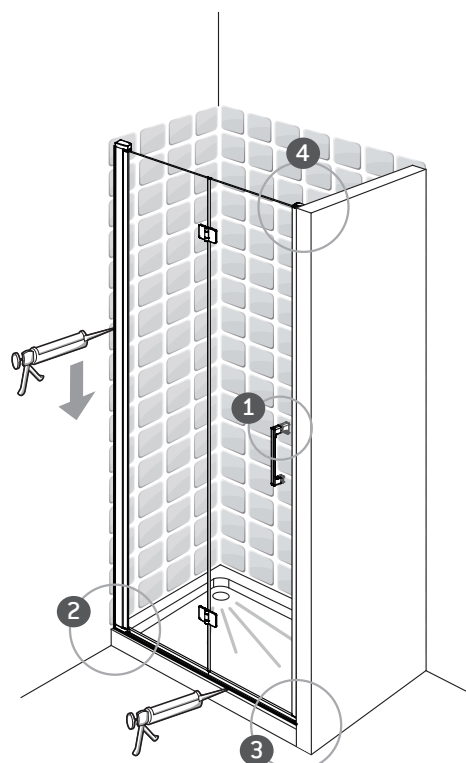
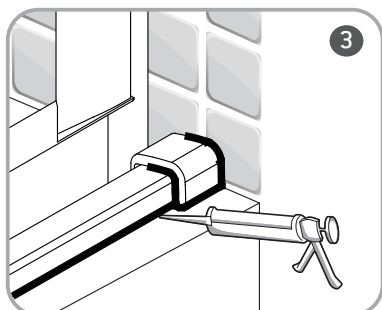
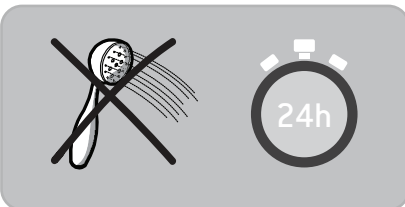
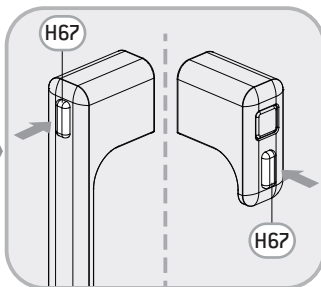
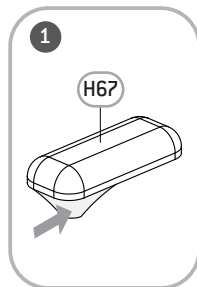

C**FR** Entretien**ES** Mantenimiento**PT** Serviço**IT** Manutenzione**EL** Συντήρηση**PL** Konserwacja**RU** Уход**UK** Догляд**RO** Întreținere**EN** Maintenance

Sans solvant / Sin disolvente / Sem solventes / Senza solventi / Χωρίς διαλυτικά / Bez rozpuszczalnika / Без растворителя / Без розчинника / Fără solvent / Solvent-free

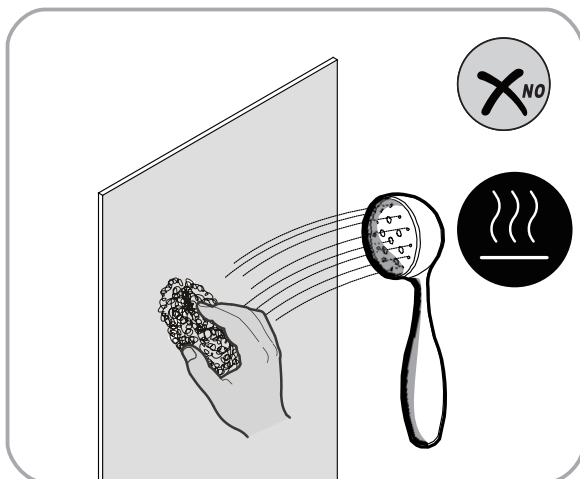
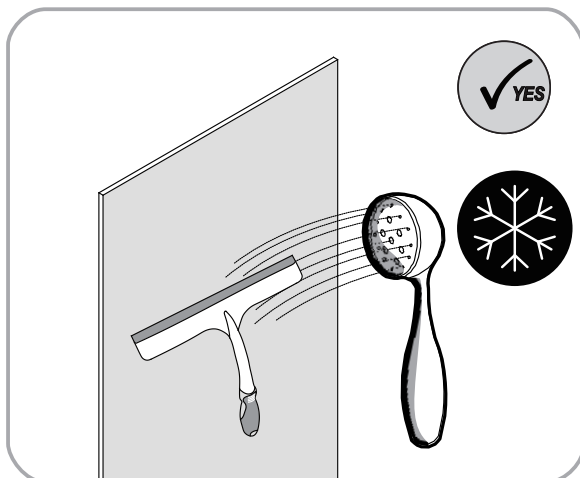

FR



ADEO Services - 135 Rue Sadi Carnot -
CS 00001 59790 RONCHIN - France
16
EN 14428:2015

Code d'identification unique
du produit-type: **
usage prévu: hygiène personnelle
Nettoyable: Conforme
Résistance à l'impact/
Capacité de Fragmentation:
durabilité: Conforme Conforme

DOP N ° 204003/0001/2016

ES



ADEO Services - 135 Rue Sadi Carnot -
CS 00001 59790 RONCHIN - France
16
EN 14428:2015

Código de identificación
única del producto tipo: **
Uso previsto: higiene personal
Limpiable: Conforme
Resistencia al impacto/
Capacidad de fragmentación:
Durabilidad: Conforme Conforme

DOP N ° 204003/0001/2016

PT



ADEO Services - 135 Rue Sadi Carnot -
CS 00001 59790 RONCHIN - France
16
EN 14428:2015

Código de identificação
único do produto-tipo: **
Utilização prevista: higiene pessoal
Limpeza: Conforme
Resistência ao impacto/
Capacidade de fragmentação:
Durabilidade: Conforme Conforme

DOP N ° 204003/0001/2016

IT



ADEO Services - 135 Rue Sadi Carnot -
CS 00001 59790 RONCHIN - France
16
EN 14428:2015

Codice di identificazione
unico del prodotto-tipo: **
Uso previsto: igiene personale
Pulibile: Conforme
Resistenza agli urti/
Capacità di Frammentazione:
Durata: Conforme Conforme

DOP N ° 204003/0001/2016

EL



ADEO Services - 135 Rue Sadi Carnot -
CS 00001 59790 RONCHIN - France
16
EN 14428:2015

Μοναδικός κωδικός ταυτοποίησης
του τύπου του προϊόντος: **
προβλεπόμενη χρήση: προσωπική υγιεινή
Δυνατότητα καθαρισμού: Σύμφωνα με
Αντοχή σε κρούση/
Ικανότητα κατάτμησης: Σύμφωνα με
Διάρκεια: Σύμφωνα με

DOP N ° 204003/0001/2016

PL



ADEO Services - 135 Rue Sadi Carnot -
CS 00001 59790 RONCHIN - France
16
EN 14428:2015

Niepowtarzalny kod
identyfikacyjny typu wyrobu: **
przeznaczenie: higiena osobista
Możliwość czyszczenia: Zgodny
Odporność na uderzenia/
Rozkruszalność: Zgodny
Trwałość: Zgodny

DOP N ° 204003/0001/2016

RU



ADEO Services - 135 Rue Sadi Carnot -
CS 00001 59790 RONCHIN - France
16
EN 14428:2015

Уникальный идентификационный
код типа изделия: **
Назначение: личная гигиена
Легкость очистки: Соответствие
Ударопрочность/
Мощность распыления: Соответствие
Долговечность: Соответствие

DOP N ° 204003/0001/2016

UK



ADEO Services - 135 Rue Sadi Carnot -
CS 00001 59790 RONCHIN - France
16
EN 14428:2015

Унікальний ідентифікаційний
код виду продукції: **
призначення: особиста гігієна
Легкість очищення: Відповідність
Ударостійкість/
Потужність розпилення: Відповідність
Довговічність: Відповідність

DOP N ° 204003/0001/2016

RO



ADEO Services - 135 Rue Sadi Carnot -
CS 00001 59790 RONCHIN - France
16
EN 14428:2015

Cod unic de identificare
a tipului de produs: **
destinație: igienă personală
Posibilitatea de curățare: Conform
Rezistență la impact/
Capacitate de fragmentare: Conform
Durabilitate: Conform

DOP N ° 204003/0001/2016

EN



ADEO Services - 135 Rue Sadi Carnot -
CS 00001 59790 RONCHIN - France
16
EN 14428:2015

Unique identification code
of the product-type: **
Intended use: personal hygiene
cleanability: Pass
Impact resistance/ shatter properties: Pass
Durability: Pass

DOP N ° 204003/0001/2016

**

FR Reportez-vous à l'annexe.

ES Consulte el apéndice.

PT Consulte o anexo.

IT Consultare l'appendice.

EL Ανατρέξτε στο Παράρτημα.

PL Patrz załącznik.

RU См. приложение.

UK Читайте додаток.

RO Consultați anexa.

EN Refer to appendix.

ADEO Services
135 Rue Sadi Carnot
CS 00001
59790 RONCHIN - France

ТОВ «Леруа Мерлен Україна»,
вул. Полярна 17а, м. Київ
04201, Україна

ООО ЛЕРУА МЕРЛЕН ВОСТОК,
141031, Московская область,
Мытищинский район, г. Мытищи,
Осташковское шоссе, д.1, РОССИЯ

* Garantie 3 ans / Garantía 3 años / Garantia 3 anos / Garanzia 3 anni
Εγγύηση 3 ετών / Gwarancja 3 lat / 3 летняя / 3-річна гарантія
3 ani garanție / Guarantee 3 years

Made In P. R.C. 2016